

# **v:KO**

by **Panasonic**



**Distribution Boxes**

User friendly design...





Safety and design have met within VIKO distribution boxes. Sensitive safety thanks to plastic's insulative nature and decorative appearance due to aesthetical lines are together within the VIKO breaker boxes and in life. On the other hand, resisting against heat and impacts thanks to its strong structure, these breaker boxes also meet work comfort expectations in the best possible way with their large inner volume.

# Distribution Boxes



VIKO breaker boxes deliver safety with plastic's insulative nature and an aesthetic view with their outstanding design. Meets your expectations thanks to its heat-and-impact-resistant structure and large inner volume which offers a comfortable work.

- Conform to IP40 protection standard.
- Class II; electric shock-protected.
- Temperature range during installation  $-15^{\circ}\text{C}$  /  $+60^{\circ}\text{C}$ .
- Flame and fire-resistant up to  $650^{\circ}\text{C}$ .
- Has  $180^{\circ}$  screw-in covers depending on the place of use.
- Breaker rail is made of galvanized sheet.
- Provides comfort in mounting and working, thanks to its large inner volume.
- Resistant against heat and impacts.
- Grounding terminal and connection accessories are available.
- Halogen-free option.
- Water gauge.



## Terminal



**4-Terminal**  
90910001

**6-Terminal**  
90910002

**9-Terminal**  
90910003

**10-Terminal**  
90910004

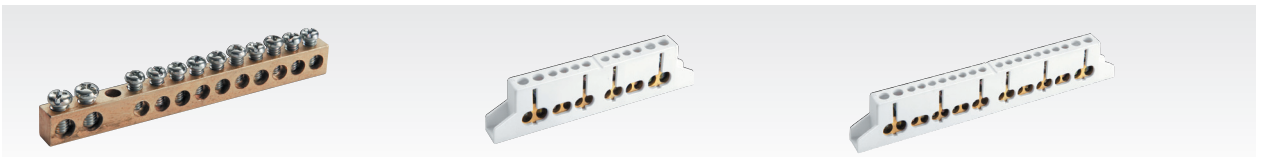

**12-Terminal**  
90910005

**Insulated Neutral Earth Terminal - 2x6**  
90911002

**Insulated Neutral Earth Terminal - 2x10**  
90911005

### 1-Surface Mounted 90914000

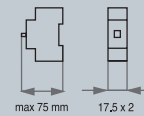
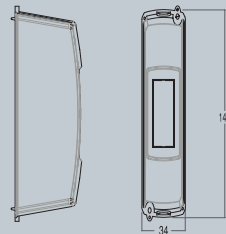

### 1-2-Surface Mounted 90914001

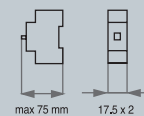
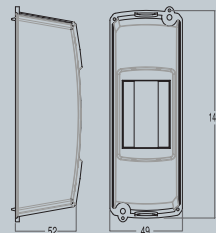

### 3-4-Surface Mounted 90914003

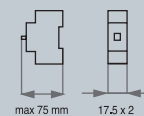
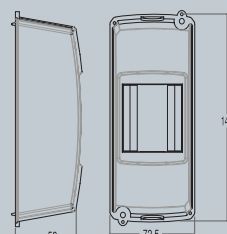

# Distribution Boxes

2-Flush Mounted 90912002

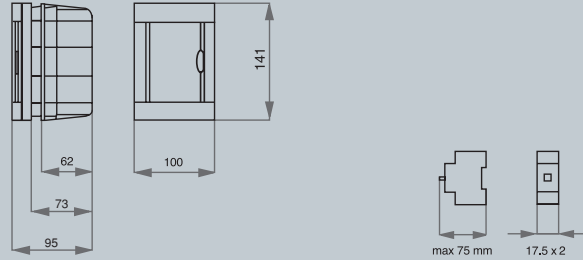

4-Flush Mounted 90912004

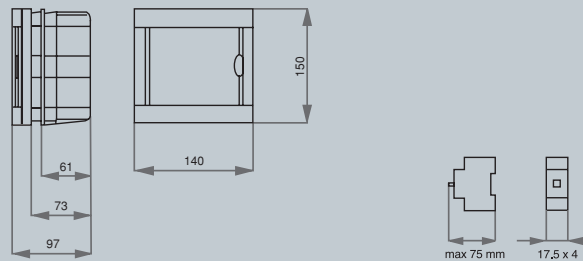

6-Flush Mounted 90912006

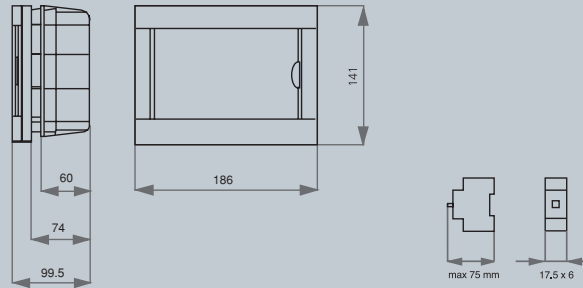

8-Flush Mounted 90912008



Locked cover system.

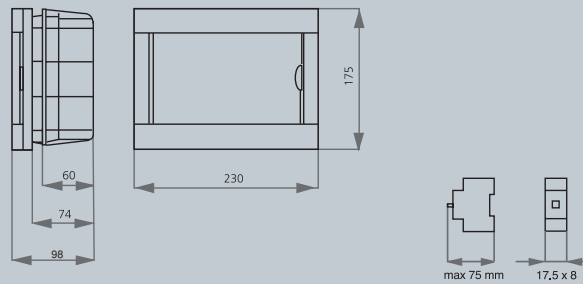

12-Flush Mounted 90912012



Locked cover system.

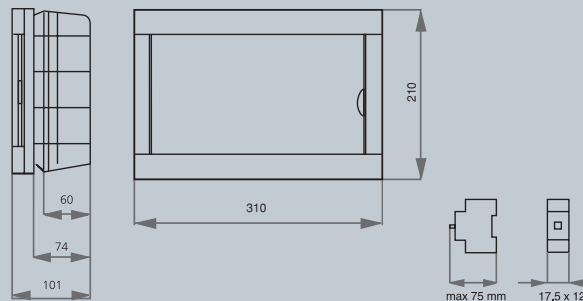

**16-Flush Mounted 90912016**



Locked cover system.

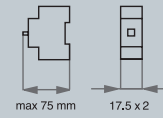
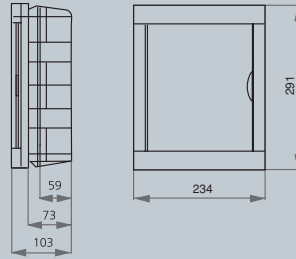

**18-Flush Mounted 90912018**



Locked cover system.

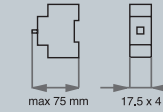
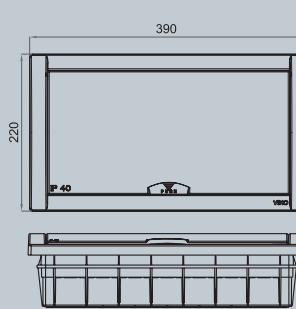

**24-Flush Mounted 90912024**



Locked cover system.

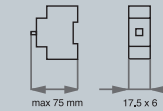
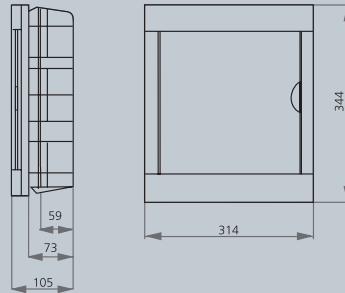

**36-Flush Mounted 90912036**



Locked cover system.

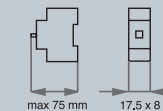
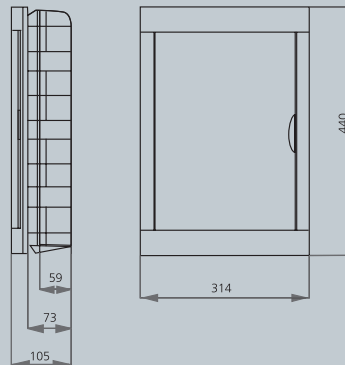

# Distribution Boxes

2-Surface Mounted 90912102

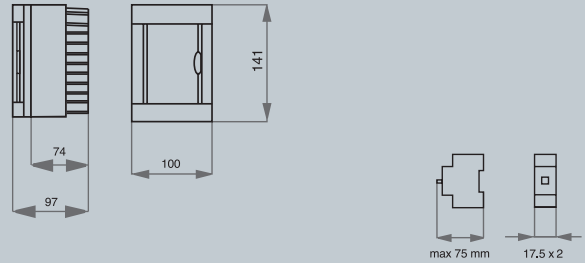

4-Surface Mounted 90912104

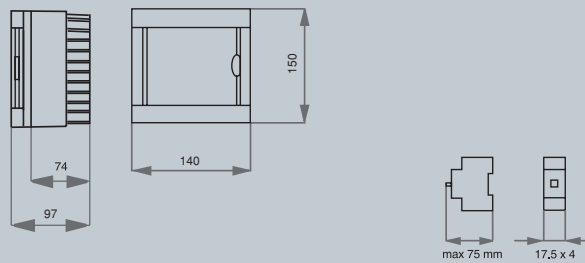

6-Surface Mounted 90912106

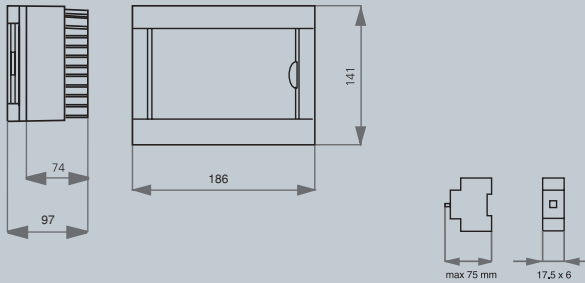

8-Surface Mounted 90912108



Locked cover system.

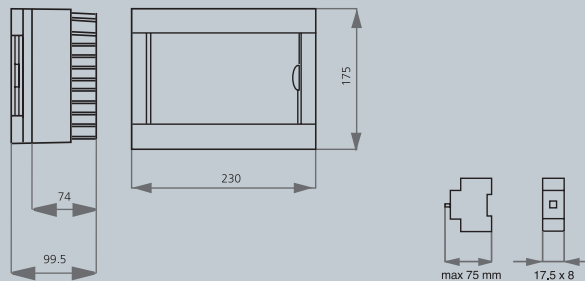

12-Surface Mounted 90912112



Locked cover system.

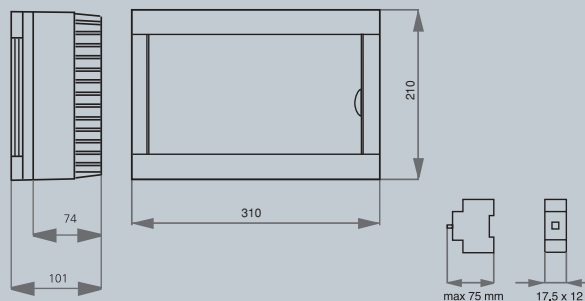



**16-Surface Mounted 90912116**



Locked cover system.

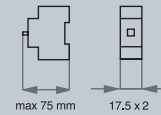
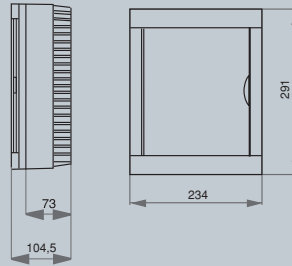

**18-Surface Mounted 90912118**



Locked cover system.

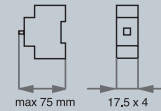
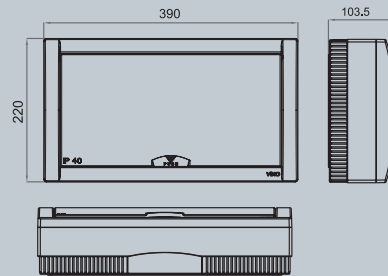

**24-Surface Mounted 90912124**



Locked cover system.

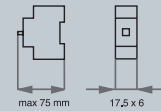
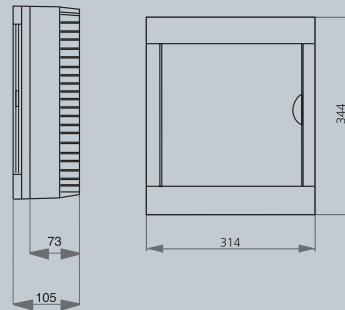

**36-Surface Mounted 90912136**



Locked cover system.

