

# Panasonic



karre plus

# fascinating anatomy

## Mechanism: Thinness and resistance

Resistant metal frame with a thickness of 1 mm ensures the desired performance during the installation. Extra details added to the metal frames provide help to make the alignment as desired. Assemblies are safely carried out with its specially rolled non-hurting tabs.

## Retainer: Strong and durable

Retainer that is designed with an ideal proportion to fasten the button and covers securely meets the expectations for endurance and strength desired during the usage and replacement of covers.

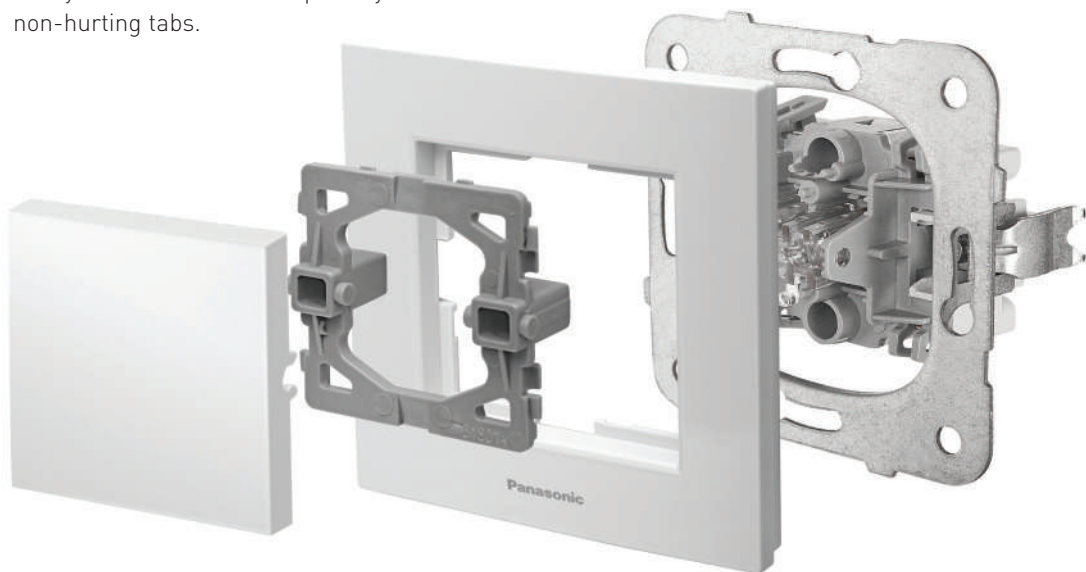

## Frame: Chic and modern

Frames in square forms with modern designs having two-unit, three-unit, four-unit, five-unit, six-unit options that can be used vertically and horizontally according to the decorations offer the trends of today in its color alternatives.

## Button: Single, double or illuminated options

Replaceable buttons and covers with single, binary or illuminated options are available in different colors.



LED lighting in illuminated switches

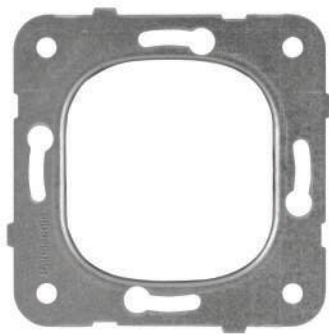

Resistant metal frame with a thickness of 1 mm



Non-hurting rolled special tab structure

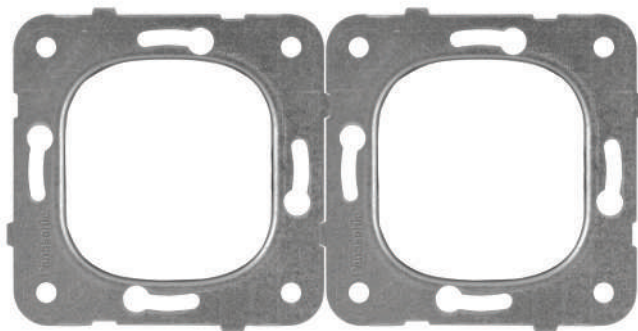

Details assisting the alignment added to the metal frame for perfect assembly

# modern choices modern homes



## Digital Programmable Shutter Control

Programmable Shutter Control with both daily and weekly programmable digital display having special theft scenario.



Digital Programmable Shutter Control  
Graphic LCD display  
Easy-to-use menus  
Power reserve exceeding 6 hours  
Semi-open, open, closed modes  
Summer / Winter - 2 separate weeks scheduling feature

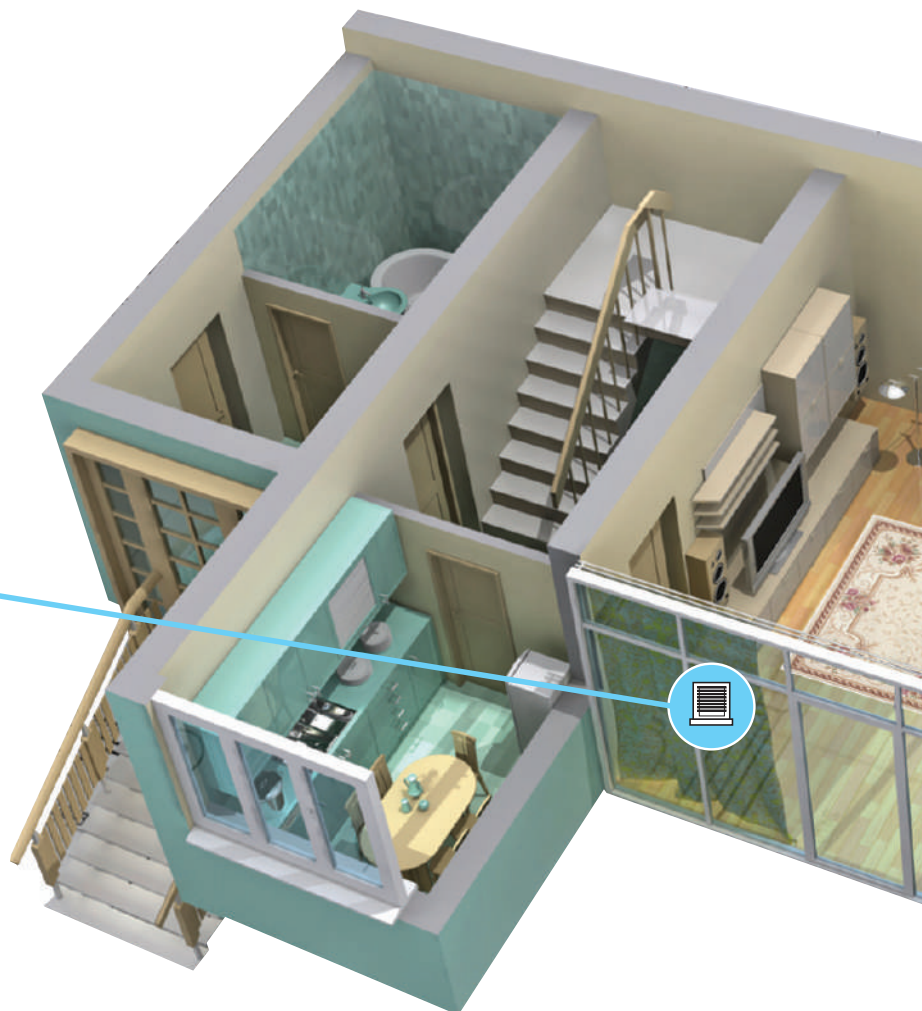



## PRO Dimmer Family

Meet new PRO DIMMER offering comfort, coziness and superior protection with its technology and design.



**RLC PRO Dimmer**  
Smart dimmer feature  
Overcurrent Protection  
Overload protection (thermal)  
RLC - 20W - 350W  
R,L and C load types

**RL PRO Dimmer**  
Short-Circuit Protection  
Overload protection (thermal)  
20W -500W, R and L load types  
Two-way feature

**RC PRO Dimmer**  
Short-Circuit Protection  
Overload protection (thermal) 40W - 400W,  
R and C load types  
Two-way feature

**1-10V Potentiometer**  
Dims the fluorescent lamps by connecting to the dimmable ballast.  
Switching current is 6A

- 4 different models as RL, RC, RLC and 1-10V dimmers according to the lighting types to be used.
- Superior protection against the errors arising from installation and lighting with Over Load and Short Circuit Protection Feature.
- Ease of turning on and off by a single touch thanks to this Push On-Off feature
- Two-way feature in PRO RL and PRO RC series.
- Compliance with all dimmable lamp types with load identification feature in PRO RLC series

## Analog and Programmable Digital Thermostat

Temperature setting with high precision thanks to the special PI algorithm! Programmable Digital Thermostat with backlit, user-friendly menu supported by 7 languages.



**Analog Thermostat**  
Temperature setting between 10°C - 30°C  
+/- 1°C measurement precision  
Warning lamp  
Protection against freezing



**Programmable Digital Thermostat**  
Temperature setting between 5°C - 30°C  
+/- 1°C measurement precision  
Graphic LCD display  
Menu to use easily  
Power reserve exceeding 6 hours  
Outside, at home and night modes  
Summer / Winter - 2 separate weeks scheduling feature (weekday, weekend, whole week)  
Protection against freezing

## Switches (Complete)

**WKTC0001-2** □□

One-way Switch  
10AX, 250V~  
Color ○○



**WKTC0002-2** □□

One-way Switch, Illum.  
10AX, 250V~  
Color ○○



**WKTC0009-2** □□

2-gang One-way Switch  
10AX, 250V~  
Color ○○



**WKTC0010-2** □□

2-gang One-way Switch, Illum.  
10AX, 250V~  
Color ○○



**WKTC0003-2** □□

Two-way Switch  
10AX, 250V~  
Color ○○



**WKTC0004-2** □□

Two-way Switch, Illum.  
10AX, 250V~  
Color ○○



**WKTC0016-2** □□

One-way Push Button  
10AX, 250V~  
Color ○○



**WKTC0017-2** □□

Push Button, Illum.  
10AX, 250V~  
Color ○○



**WKTC0019-2** □□

Push Button with  
Bell Symbol  
10AX, 250V~  
Color ○○



**WKTC0020-2** □□

Push Button w Label,  
Illum. 10AX, 24V~  
Color ○○



**WKTC0018-2** □□

Push Button with  
Key Symbol, 10AX, 250V~  
Color ○○



**WKTC0005-2** □□

Intermediate Switch  
10AX, 250V~  
Color ○○



**WKTC0022-2** □□

Shutter Control,  
Push Button  
10AX, 250V~  
Color ○○



**WKTC0011-2** □□

2-gang Two-way Switch  
10AX, 250V~  
Color ○○



**WKTC0012-2** □□

Double One-way Switch  
10AX, 250V~  
Color ○○



**WKTC0013-2** □□

Double One-way  
Push Button  
10AX, 250V~  
Color ○○



**WKTC0043-2** □□

2-pole Switch  
16AX, 250V~  
Color ○○



**WKTC0044-2** □□

2-pole Switch, Illum.,  
16AX, 250V~  
Color ○○



**WKTC0015-2** □□

3-gang One-way Switch  
10AX, 250V~  
Color ○○



**WKTC0025-2** □□

Emergency Push  
Button with Cord  
10AX, 250V~  
Color ○○



**Sockets (Complete)**

**WKTC0201-2** □□  
 Socket 2P  
 16A, 250V~  
 Color ○ ○



**WKTC0211-2** □□  
 Socket 2P, Safety Shutter  
 16A, 250V~  
 Color ○ ○



**WKTC0202-2** □□  
 Socket 2P+E  
 16A, 250V~  
 Color ○ ○



**WKTC0212-2** □□  
 Socket 2P+E, Safety Shutter  
 16A, 250V~  
 Color ○ ○



**WKTC0210-2** □□  
 Socket 2P+E, Lid and Safety Shutter  
 16A, 250V~  
 Color ○ ○



**WKTC0213-2** □□  
 Socket 2P+E French, Safety Shutter  
 16A, 250V~  
 Color ○ ○



**WKTC0217-2** □□  
 Socket 2P+E French,  
 Lid and Safety Shutter  
 16A, 250V~  
 Color ○ ○



**WKTC0204-2** □□  
 Double Socket 2P  
 16A, 250V~  
 Color ○ ○



**WKTC0214-2** □□  
 Double Socket 2P, Safety Shutter, Comp.  
 16A, 250V~  
 Color ○ ○



**WKTC0205-2** □□  
 Double Socket 2P+E  
 16A, 250V~  
 Color ○ ○





**WKTC0215-2** □□  
 Double Socket 2P+E,  
 Safety Shutter  
 16A, 250V~  
 Color ○ ○



**WKTC0216-2** □□  
 Double Socket 2P+E French,  
 Safety Shutter  
 16A, 250V~  
 Color ○ ○



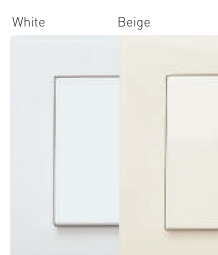

**Variety of Colors**



The last 2 characters in □□ of product numbers show the item color.

- White — WH
- Beige — BG

**Type of Terminals and Electrical Cables**

	Solid Wire	Stranded Wire	Flexible Wire
 <b>Screw Terminal</b>	1.0-2.5mm <sup>2</sup>	1.0-2.5mm <sup>2</sup>	—
 <b>Screw Terminal</b>	1.5-2.5mm <sup>2</sup>	1.5-2.5mm <sup>2</sup>	—

## Dimmers (Complete)

**WKTC0525-2** □ □  
 Rotary Dimmer RC 40-400W  
 230V~  
 Color ○ ○



**WKTC0524-2** □ □  
 Rotary Dimmer RLC 20-350W  
 230V~  
 Color ○ ○



**WKTC0527-2** □ □  
 Rotary Dimmer 1-10V  
 Color ○ ○



## Telephone and Data Sockets (Complete)

**WKTC0402-2** □ □  
 RJ11 CAT3  
 Color



**WKTC0404-2** □ □  
 RJ45 CAT5E  
 Color ○ ○



**WKTC0405-2** □ □  
 RJ45 CAT6  
 Color ○ ○



**WKTC0403-2** □ □  
 Double RJ11 CAT3  
 Color ○ ○



**WKTC0406-2** □ □  
 Double RJ45 CAT5E  
 Color ○ ○



**WKTC0407-2** □ □  
 Double RJ45 CAT6  
 Color ○ ○



**WKTC0408-2** □ □  
 RJ45 CAT5E + RJ11 CAT3  
 Color ○ ○



**WKTC0409-2** □ □  
 RJ45 CAT6 + RJ11 CAT3  
 Color ○ ○



## Television Sockets (Complete)

**WKTC0412-2** □ □  
 Double Keystone Socket  
 w/o conn.  
 Color ○ ○



**WKTC0451-2** □ □  
 TV Socket, Terminated  
 Color ○ ○



**WKTC0452-2** □ □  
 TV Socket, Thr.-pass (12dB)  
 Color ○ ○



**WKTC0454-2** □ □  
 TV Socket, Lossless  
 Color ○ ○



**WKTC0458-2** □ □  
 SAT Socket, Terminated  
 Color ○ ○



**WKTC0459-2** □ □  
 SAT Socket, Thr.-pass (10dB)  
 Color ○ ○



**WKTC0460-2** □ □  
 TV-SAT Socket,  
 Terminated  
 Color ○ ○



**WKTC0461-2** □ □  
 TV-SAT Socket, Thr.-pass (11dB)  
 Color ○ ○





**Telephone and Data Sockets (Complete)**

**WKTC0463-2** □□  
TV-RAD-SAT Socket,  
Terminated  
Color ○○



**WKTC0466-2** □□  
SAT-SAT-TV Socket,  
Terminated  
Color ○○



**Audio Control and Audio Socket (Complete)**

**WKTC0561-2** □□  
Volume Control Switch  
Color ○○



**WKTC0563-2** □□  
Audio Channel  
Selection Switch  
Color ○○



**Accessories (Complete)**

**WKTC0560-2** □□  
Audio Socket  
Color ○○



**WKTC0702-2** □□  
Cable Outlet  
Color ○○



**WKTC0701-2** □□  
Blank Cover  
Color ○○



**WKTC0791-9** □□  
Surface Mounting Box, Single  
Color ○○



**WKTC0792-9** □□  
Surface Mounting Box, Double  
Color ○○



**WKTC0712-4NC**  
IP44 Gasket Kit for Switch



**WKTC0713-4NC**  
IP44 Gasket Kit for  
2-gang Switch

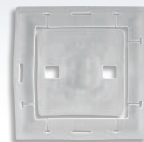

**WKTC0711-4NC**  
IP44 Gasket Kit for Socket  
with Lid



**Variety of Colors**

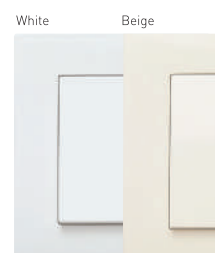

The last 2 characters  
in □□ of product numbers  
show the item color.

- White — WH
- Beige — BG

## Switches (Mechanism + Rocker)

**WKTT0001-2** □□

One-way Switch  
10AX, 250V~  
Color ○ ○ ○ ○ ● ●



**WKTT0002-2** □□

One-way Switch, Illum.  
10AX, 250V~  
Color ○ ○ ○ ○ ● ●



**WKTT0009-2** □□

2-gang One-way Switch  
10AX, 250V~  
Color ○ ○ ○ ○ ● ●



**WKTT0010-2** □□

2-gang One-way Switch, Illum.  
10AX, 250V~  
Color ○ ○ ○ ○ ● ●



**WKTT0003-2** □□

Two-way Switch  
10AX, 250V~  
Color ○ ○ ○ ○ ● ●



**WKTT0004-2** □□

Two-way Switch, Illum.  
10AX, 250V~  
Color ○ ○ ○ ○ ● ●



**WKTT0016-2** □□

One-way Push Button  
10AX, 250V~  
Color ○ ○ ○ ○ ● ●



**WKTT0017-2** □□

Push Button, Illum.  
10AX, 250V~  
Color ○ ○ ○ ○ ● ●



**WKTT0019-2** □□

Push Button w Bell Symbol  
10AX, 250V~  
Color ○ ○ ○ ○ ● ●



**WKTT0020-2** □□

Push Button w Label, Illum.  
10AX, 24V~  
Color ○ ○ ○ ○ ● ●



**WKTT0018-2** □□

Push Button with Key Symbol,  
Comp10AX, 250V~  
Color ○ ○ ○ ○ ● ●



**WKTT0005-2** □□

Intermediate Switch  
10AX, 250V~  
Color ○ ○ ○ ○ ● ●



**WKTT0022-2** □□

Shutter Control, Push Button  
10AX, 250V~  
Color ○ ○ ○ ○ ● ●

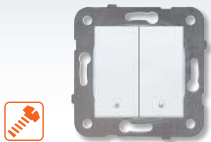

**WKTT0011-2** □□

2-gang Two-way Switch  
10AX, 250V~  
Color ○ ○ ○ ○ ● ●

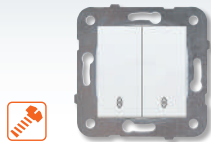

**WKTT0012-2** □□

Double One-way Switch  
10AX, 250V~  
Color ○ ○ ○ ○ ● ●

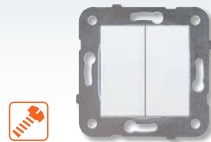

**WKTT0013-2** □□

Double One-way Push Button  
10AX, 250V~  
Color ○ ○ ○ ○ ● ●



**WKTT0043-2** □□

2-pole Switch  
16AX, 250V~  
Color ○ ○ ○ ○ ● ●



**WKTT0044-2** □□

2-pole Switch, Illum., Comp.  
16AX, 250V~  
Color ○ ○ ○ ○ ● ●



**WKTT0015-2** □□

3-gang One-way Switch  
10AX, 250V~  
Color ○ ○ ○ ○ ● ●



**WKTT0025-2** □□

Emergency Push Button w Cord  
10AX, 250V~  
Color ○ ○ ○ ○ ● ●



**Sockets (Mechanism + Cover Plate)**

<p><b>WKTT0201-2</b> □□</p> <p>Socket 2P 16A, 250V~ Color ○ ○ ○ ○ ○ ●</p>  	<p><b>WKTT0211-2</b> □□</p> <p>Socket 2P, Safety Shutter 16A, 250V~ Color ○ ○ ○ ○ ○ ●</p>  	<p><b>WKTT0202-2</b> □□</p> <p>Socket 2P+E 16A, 250V~ Color ○ ○ ○ ○ ○ ●</p>  	<p><b>WKTT0212-2</b> □□</p> <p>Socket 2P+E, Safety Shutter 16A, 250V~ Color ○ ○ ○ ○ ○ ●</p>  
<p><b>WKTT0210-2</b> □□</p> <p>Socket 2P+E, Lid and Safety Shutter 16A, 250V~ Color ○ ○ ○ ○ ○ ●</p>  	<p><b>WKTT0213-2</b> □□</p> <p>Socket 2P+E French, Safety Shutter 16A, 250V~ Color ○ ○ ○ ○ ○ ●</p>  	<p><b>WKTT0217-2</b> □□</p> <p>Socket 2P+E French, Lid and Safety Shutter 16A, 250V~ Color ○ ○ ○ ○ ○ ●</p>  	<p><b>WKTT0204-2</b> □□</p> <p>Double Socket 2P 16A, 250V~ Color ○ ○ ○ ○ ○ ●</p>  
<p><b>WKTT0214-2</b> □□</p> <p>Double Socket 2P, Safety Shutter, Comp. 16A, 250V~ Color ○ ○ ○ ○ ○ ●</p>  	<p><b>WKTT0205-2</b> □□</p> <p>Double Socket 2P+E 16A, 250V~ Color ○ ○ ○ ○ ○ ●</p>  	<p><b>WKTT0215-2</b> □□</p> <p>Double Socket 2P+E, Safety Shutter 16A, 250V~ Color ○ ○ ○ ○ ○ ●</p>  	<p><b>WKTT0216-2</b> □□</p> <p>Double Socket 2P+E French, Safety Shutter 16A, 250V~ Color ○ ○ ○ ○ ○ ●</p>  

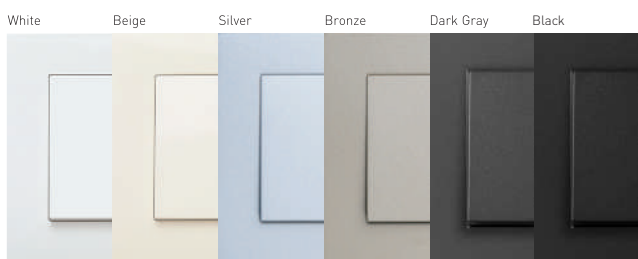

**Variety of Colors**



The last 2 characters in □□ of product numbers show the item color.

- White — WH
- Beige — BG
- Silver — SL
- Bronze — BR
- Dark Gray — DG
- Black — BL

**Type of Terminals and Electrical Cables**

	Solid Wire	Stranded Wire	Flexible Wire
 <b>Screw Terminal</b>	1.0-2.5mm <sup>2</sup>	1.0-2.5mm <sup>2</sup>	—
 <b>Screw Terminal</b>	1.5-2.5mm <sup>2</sup>	1.5-2.5mm <sup>2</sup>	—

## Dimmers (Mechanism + Cover Plate)

**WKTT0525-2** □ □  
 Rotary Dimmer RC 40-400W  
 230V-  
 Color ○ ○ ○ ○ ○ ● ●



**WKTT0524-2** □ □  
 Rotary Dimmer RLC 20-350W  
 230V-  
 Color ○ ○ ○ ○ ○ ● ●



**WKTT0527-2** □ □  
 Rotary Dimmer 1-10V  
 Color ○ ○ ○ ○ ○ ● ●



## Telephone and Data Sockets (Mechanism + Cover Plate)

**WKTT0402-2** □ □  
 RJ11 CAT3  
 Color ○ ○ ○ ○ ○ ● ●



**WKTT0404-2** □ □  
 RJ45 CAT5E  
 Color ○ ○ ○ ○ ○ ● ●



**WKTT0405-2** □ □  
 RJ45 CAT6  
 Color ○ ○ ○ ○ ○ ● ●



**WKTT0403-2** □ □  
 Double RJ11 CAT3  
 Color ○ ○ ○ ○ ○ ● ●



**WKTT0406-2** □ □  
 Double RJ45 CAT5E  
 Color ○ ○ ○ ○ ○ ● ●



**WKTT0407-2** □ □  
 Double RJ45 CAT6  
 Color ○ ○ ○ ○ ○ ● ●



**WKTT0408-2** □ □  
 RJ45 CAT5E + RJ11 CAT3  
 Color ○ ○ ○ ○ ○ ● ●



**WKTT0409-2** □ □  
 RJ45 CAT6 + RJ11 CAT3  
 Color ○ ○ ○ ○ ○ ● ●



## Television Sockets (Mechanism + Cover Plate)

**WKTT0412-2** □ □  
 Double Keystone  
 Socket w/o connector  
 Color ○ ○ ○ ○ ○ ● ●



**WKTT0451-2** □ □  
 TV Socket, Terminated  
 Color ○ ○ ○ ○ ○ ● ●



**WKTT0452-2** □ □  
 TV Socket, Thr.-pass (12dB)  
 Color ○ ○ ○ ○ ○ ● ●



**WKTT0454-2** □ □  
 TV Socket, Lossless  
 Color ○ ○ ○ ○ ○ ● ●



**WKTT0458-2** □ □  
 SAT Socket, Terminated  
 Color ○ ○ ○ ○ ○ ● ●



**WKTT0459-2** □ □  
 SAT Socket, Thr.-pass (10dB)  
 Color ○ ○ ○ ○ ○ ● ●



**WKTT0460-2** □ □  
 TV-SAT Socket,  
 Terminated  
 Color ○ ○ ○ ○ ○ ● ●



**WKTT0461-2** □ □  
 TV-SAT Socket, Thr.-pass (11dB)  
 Color ○ ○ ○ ○ ○ ● ●



**Television Sockets (Mechanism + Cover Plate)**

**WKTT0463-2** □□  
 TV-RAD-SAT Socket,  
 Terminated  
 Color ○ ● ○ ● ○ ● ○ ●

**WKTT0466-2** □□  
 SAT-SAT-TV Socket,  
 Terminated  
 Color ○ ● ○ ● ○ ● ○ ●

**Audio Control and Audio Socket (Mechanism + Cover Plate)**

**WKTT0561-2** □□  
 Volume Control Switch  
 Color ○ ● ○ ● ○ ● ○ ●

**WKTT0563-2** □□  
 Audio Channel Selection Switch  
 Color ○ ● ○ ● ○ ● ○ ●

**Thermostats (Mechanism + Cover Plate)**

**WKTT0560-2** □□  
 Audio Socket  
 Color ○ ● ○ ● ○ ● ○ ●

**WKTT0541-5** □□  
 Room Thermostat  
 Color ○ ● ○ ● ○ ● ○ ●

**WKTT0542-5** □□  
 Program. Room Thermostat  
 Color ○ ● ○ ● ○ ● ○ ●

**Shutter Control (Mechanism + Cover Plate)**

**WKTT0543-5** □□  
 Program. Shutter Control  
 Color ○ ● ○ ● ○ ● ○ ●

**Cable Outlet and Blank Covers (Mechanism + Cover Plate)**

**WKTT0702-2** □□  
 Cable Outlet  
 Color ○ ● ○ ● ○ ● ○ ●

**WKTT0701-2** □□  
 Blank Cover  
 Color ○ ● ○ ● ○ ● ○ ●

**Variety of Colors**

White      Beige      Silver      Bronze      Dark Gray      Black

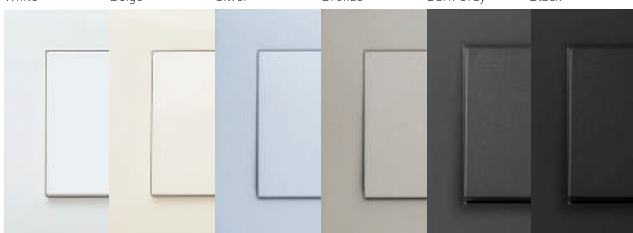

The last 2 characters in □□ of product numbers show the item color.

- White — WH
- Beige — BG
- Silver — SL
- Bronze — BR
- Dark Gray — DG
- Black — BL

## Frame

Single Frame



Horizontal 2-Gang Frame



Horizontal 3-Gang Frame



Horizontal 4-Gang Frame



Horizontal 5-Gang Frame



Horizontal 6-Gang Frame



	Single Frame	Horizontal 2-Gang Frame	Horizontal 3-Gang Frame	Horizontal 4-Gang Frame	Horizontal 5-Gang Frame	Horizontal 6-Gang Frame
White	WKTF0801-2WH	WKTF0802-2WH	WKTF0803-2WH	WKTF0804-2WH	WKTF0805-2WH	WKTF0806-2WH
Beige	WKTF0801-2BG	WKTF0802-2BG	WKTF0803-2BG	WKTF0804-2BG	WKTF0805-2BG	WKTF0806-2BG
Silver	WKTF0801-2SL	WKTF0802-2SL	WKTF0803-2SL	WKTF0804-2SL	WKTF0805-2SL	WKTF0806-2SL
Bronze	WKTF0801-2BR	WKTF0802-2BR	WKTF0803-2BR	WKTF0804-2BR	WKTF0805-2BR	WKTF0806-2BR
Dark Gray	WKTF0801-2DG	WKTF0802-2DG	WKTF0803-2DG	WKTF0804-2DG	WKTF0805-2DG	WKTF0806-2DG
Black	WKTF0801-2BL	WKTF0802-2BL	WKTF0803-2BL	WKTF0804-2BL	–	–
Aluminum Silver	WKTF0801-3AS	WKTF0802-3AS	WKTF0803-3AS	WKTF0804-3AS	–	–
Aluminum Bronze	WKTF0801-3AR	WKTF0802-3AR	WKTF0803-3AR	WKTF0804-3AR	–	–
Aluminum Black	WKTF0801-3AB	WKTF0802-3AB	WKTF0803-3AB	WKTF0804-3AB	–	–
Wooden Oak	WKTF0801-3WO	WKTF0802-3WO	WKTF0803-3WO	WKTF0804-3WO	–	–
Wooden Cherry	WKTF0801-3WK	WKTF0802-3WK	WKTF0803-3WK	WKTF0804-3WK	–	–
Wooden Walnut	WKTF0801-3WW	WKTF0802-3WW	WKTF0803-3WW	WKTF0804-3WW	–	–
Corian Sandstone	WKTF0801-3CS	WKTF0802-3CS	WKTF0803-3CS	WKTF0804-3CS	–	–
Corian Dusk	WKTF0801-3CD	WKTF0802-3CD	WKTF0803-3CD	WKTF0804-3CD	–	–
Corian Blackquartz	WKTF0801-3CB	WKTF0802-3CB	WKTF0803-3CB	WKTF0804-3CB	–	–
Glass Light Green	WKTF0801-3GG	WKTF0802-3GG	WKTF0803-3GG	WKTF0804-3GG	–	–
Glass Claret Red	WKTF0801-3GC	WKTF0802-3GC	WKTF0803-3GC	WKTF0804-3GC	–	–
Glass Black	WKTF0801-3GB	WKTF0802-3GB	WKTF0803-3GB	WKTF0804-3GB	–	–

Variety of Colors



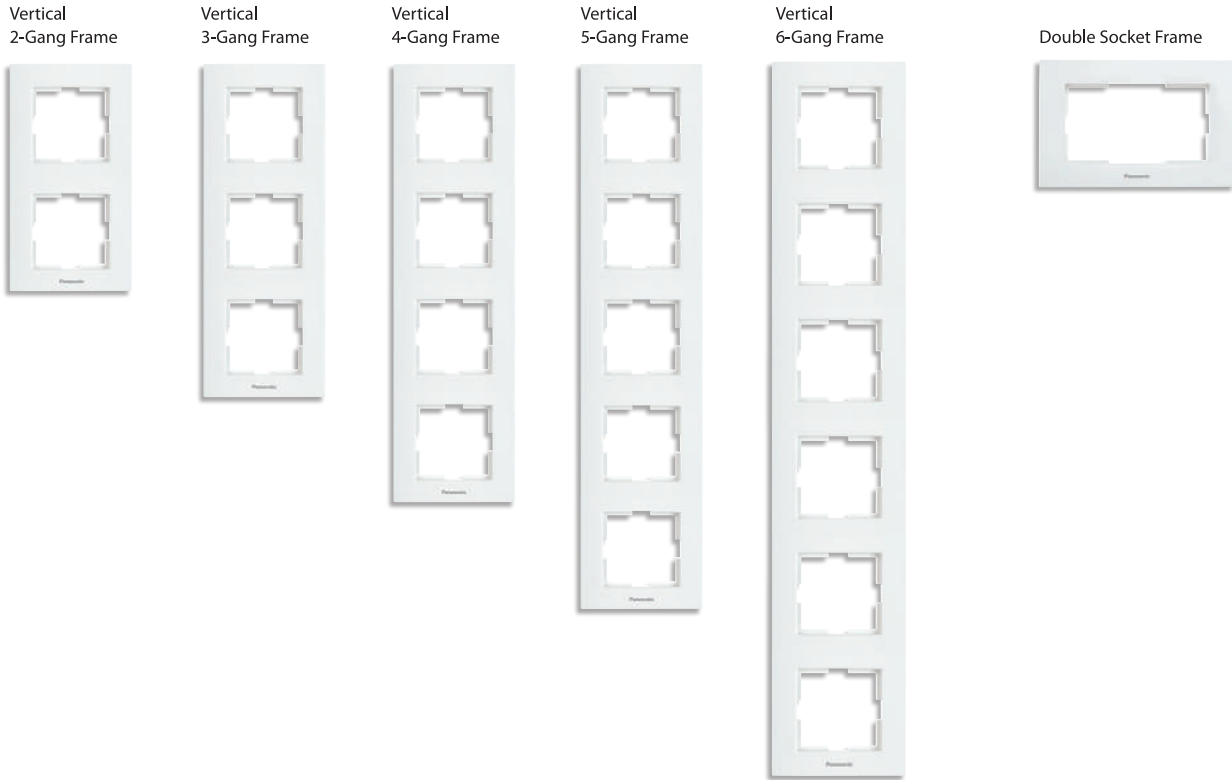

	Vertical 2-Gang Frame	Vertical 3-Gang Frame	Vertical 4-Gang Frame	Vertical 5-Gang Frame	Vertical 6-Gang Frame	Double Socket Frame
<b>White</b>	WKTF0812-2WH	WKTF0813-2WH	WKTF0814-2WH	WKTF0815-2WH	WKTF0816-2WH	WKTF0809-2WH
<b>Beige</b>	WKTF0812-2BG	WKTF0813-2BG	WKTF0814-2BG	WKTF0815-2BG	WKTF0816-2BG	WKTF0809-2BG
<b>Silver</b>	WKTF0812-2SL	WKTF0813-2SL	WKTF0814-2SL	WKTF0815-2SL	WKTF0816-2SL	WKTF0809-2SL
<b>Bronze</b>	WKTF0812-2BR	WKTF0813-2BR	WKTF0814-2BR	WKTF0815-2BR	WKTF0816-2BR	WKTF0809-2BR
<b>Dark Gray</b>	WKTF0812-2DG	WKTF0813-2DG	WKTF0814-2DG	WKTF0815-2DG	WKTF0816-2DG	WKTF0809-2DG
<b>Black</b>	WKTF0812-2BL	WKTF0813-2BL	WKTF0814-2BL	–	–	–
<b>Aluminum Silver</b>	WKTF0812-3AS	WKTF0813-3AS	WKTF0814-3AS	–	–	WKTF0809-3AS
<b>Aluminum Bronze</b>	WKTF0812-3AR	WKTF0813-3AR	WKTF0814-3AR	–	–	WKTF0809-3AR
<b>Aluminum Black</b>	WKTF0812-3AB	WKTF0813-3AB	WKTF0814-3AB	–	–	WKTF0809-3AB
<b>Wooden Oak</b>	WKTF0812-3WO	WKTF0813-3WO	WKTF0814-3WO	–	–	WKTF0809-3WO
<b>Wooden Cherry</b>	WKTF0812-3WK	WKTF0813-3WK	WKTF0814-3WK	–	–	WKTF0809-3WK
<b>Wooden Walnut</b>	WKTF0812-3WW	WKTF0813-3WW	WKTF0814-3WW	–	–	WKTF0809-3WW
<b>Corian Sandstone</b>	WKTF0812-3CS	WKTF0813-3CS	WKTF0814-3CS	–	–	WKTF0809-3CS
<b>Corian Dusk</b>	WKTF0812-3CD	WKTF0813-3CD	WKTF0814-3CD	–	–	WKTF0809-3CD
<b>Corian Blackquartz</b>	WKTF0812-3CB	WKTF0813-3CB	WKTF0814-3CB	–	–	WKTF0809-3CB
<b>Glass Light Green</b>	WKTF0812-3GG	WKTF0813-3GG	WKTF0814-3GG	–	–	WKTF0809-3GG
<b>Glass Claret Red</b>	WKTF0812-3GC	WKTF0813-3GC	WKTF0814-3GC	–	–	WKTF0809-3GC
<b>Glass Black</b>	WKTF0812-3GB	WKTF0813-3GB	WKTF0814-3GB	–	–	WKTF0809-3GB

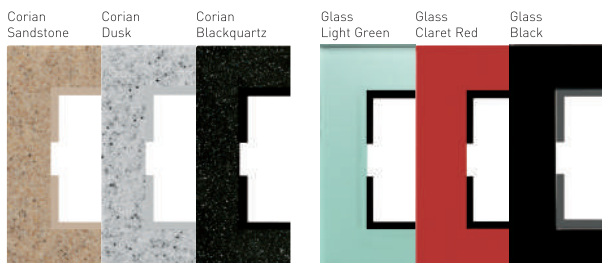

# home style







Simple but flashy Arkedia exposes the inner beauty of the living spaces. Starting its journey from the indispensability of white and beige, Arkedia completes the decorations with comfort thanks to the wide range of product that meets expectations and preferences.

arkedia

# style and grace



Arkedia is much more than an electric switch for living spaces with its style and concept of grace. Arkedia brings together refined elegance, modernity, comfort and safety.



# Panasonic



Arkedia is in harmony with every decorative environment.  
Comforting visual difference is achieved with a little touch...



## Switches (Complete)

**WMTC0001-2** □□

One-way Switch  
10AX, 250V~  
Color ○○



**WMTC0002-2** □□

One-way Switch, Illum.  
10AX, 250V~  
Color ○○



**WMTC0009-2** □□

2-gang One-way Switch  
10AX, 250V~  
Color ○○



**WMTC0010-2** □□

2-gang One-way  
Switch, Illum.  
10AX, 250V~  
Color ○○



**WMTC0003-2** □□

Two-way Switch  
10AX, 250V~  
Color ○○



**WMTC0004-2** □□

Two-way Switch, Illum.  
10AX, 250V~  
Color ○○



**WMTC0016-2** □□

One-way Push Button  
10AX, 250V~  
Color ○○



**WMTC0017-2** □□

Push Button, Illum.  
10AX, 250V~  
Color ○○



**WMTC0019-2** □□

Push Button with  
Bell Symbol  
10AX, 250V~  
Color ○○



**WMTC0020-2** □□

Push Button with Label,  
Illum. 10AX, 24V~  
Color ○○



**WMTC0018-2** □□

Push Button with  
Key Symbol, Comp.  
10AX, 250V~  
Color ○○



**WMTC0005-2** □□

Intermediate Switch  
10AX, 250V~  
Color ○○



**WMTC0022-2** □□

Shutter Control,  
Push Button  
10AX, 250V~  
Color ○○



**WMTC0011-2** □□

2-gang Two-way Switch  
10AX, 250V~  
Color ○○



**WMTC0012-2** □□

Double One-way Switch  
10AX, 250V~  
Color ○○



**WMTC0013-2** □□

Double One-way  
Push Button  
10AX, 250V~  
Color ○○



**WMTC0044-2** □□

2-pole Switch,  
Illum., Comp.  
16AX, 250V~  
Color ○○



**WMTC0015-2** □□

3-gang One-way Switch  
10AX, 250V~  
Color ○○



**WMTC0025-2** □□

Emergency Push  
Button with Cord  
10AX, 250V~  
Color ○○



Sockets (Complete)

**WMTC0201-2** □□  
 Socket 2P  
 16A, 250V~  
 Color ○ ○



**WMTC0211-2** □□  
 Socket 2P, Safety Shutter  
 16A, 250V~  
 Color ○ ○



**WMTC0202-2** □□  
 Socket 2P+E  
 16A, 250V~  
 Color ○ ○



**WMTC0212-2** □□  
 Socket 2P+E, Safety Shutter  
 16A, 250V~  
 Color ○ ○



**WMTC0210-2** □□  
 Socket 2P+E, Lid and Safety Shutter  
 16A, 250V~  
 Color ○ ○



**WMTC0213-2** □□  
 Socket 2P+E French, Safety Shutter  
 16A, 250V~  
 Color ○ ○



**WMTC0204-2** □□  
 Double Socket 2P  
 16A, 250V~  
 Color ○ ○



**WMTC0214-2** □□  
 Double Socket 2P, Safety Shutter, Comp.  
 16A, 250V~  
 Color ○ ○





**WMTC0205-2** □□  
 Double Socket 2P+E  
 16A, 250V~  
 Color ○ ○



**WMTC0215-2** □□  
 Double Socket 2P+E,  
 Safety Shutter  
 16A, 250V~  
 Color ○ ○



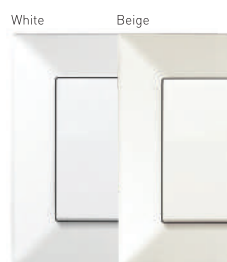

Variety of Colors



The last 2 characters in □□ of product numbers show the item color.

- White — WH
- Beige — BG

Type of Terminals and Electrical Cables

		Solid Wire	Stranded Wire	Flexible Wire
	<b>Screw Terminal</b>	1.0-2.5mm <sup>2</sup>	1.0-2.5mm <sup>2</sup>	—
	<b>Screw Terminal</b>	1.5-2.5mm <sup>2</sup>	1.5-2.5mm <sup>2</sup>	—

## Telephone and Data Sockets (Complete)

<p><b>WMTC0402-2</b> □□</p> <p>RJ11 CAT3 Color ○○</p> 	<p><b>WMTC0404-2</b> □□</p> <p>RJ45 CAT5E Color ○○</p> 	<p><b>WMTC0405-2</b> □□</p> <p>RJ45 CAT6 Color ○○</p> 	<p><b>WMTC0403-2</b> □□</p> <p>Double RJ11 CAT3 Color ○○</p> 
<p><b>WMTC0406-2</b> □□</p> <p>Double RJ45 CAT5E Color ○○</p> 	<p><b>WMTC0407-2</b> □□</p> <p>Double RJ45 CAT6 Color ○○</p> 	<p><b>WMTC0408-2</b> □□</p> <p>RJ45 CAT5E + RJ11 CAT3 Color ○○</p> 	<p><b>WMTC0409-2</b> □□</p> <p>RJ45 CAT6 + RJ11 CAT3 Color ○○</p> 

## Television Sockets (Complete)

<p><b>WMTC0412-2</b> □□</p> <p>Double Keystone Socket w/o conn. Color ○○</p> 	<p><b>WMTC0451-2</b> □□</p> <p>TV Socket, Terminated Color ○○</p> 	<p><b>WMTC0452-2</b> □□</p> <p>TV Socket, Thr.-pass (12dB) Color ○○</p> 	<p><b>WMTC0454-2</b> □□</p> <p>TV Socket, Lossless Color ○○</p> 
<p><b>WMTC0458-2</b> □□</p> <p>SAT Socket, Terminated Color ○○</p> 	<p><b>WMTC0459-2</b> □□</p> <p>SAT Socket, Thr.-pass (10dB) Color ○○</p> 	<p><b>WMTC0460-2</b> □□</p> <p>TV-SAT Socket, Terminated Color ○○</p> 	<p><b>WMTC0461-2</b> □□</p> <p>TV-SAT Socket, Thr.-pass (11dB) Color ○○</p> 

## Audio Control and Audio Socket (Complete)

<p><b>WMTC0463-2</b> □□</p> <p>TV-RAD-SAT Socket, Terminated Color ○○</p> 	<p><b>WMTC0466-2</b> □□</p> <p>SAT-SAT-TV Socket, Terminated Color ○○</p> 	<p><b>WMTC0561-2</b> □□</p> <p>Volume Control Switch Color ○○</p> 	<p><b>WMTC0560-2</b> □□</p> <p>Audio Socket Color ○○</p> 
---	---	--	--

Accessories (Complete)

WMTC0702-2 □□

Cable Outlet  
Color ○○



WMTC0701-2 □□

Blank Cover  
Color ○○



WMTC0792-9 □□

Surface Mounting Box, Double  
Color ○○



Variety of Colors



The last 2 characters in □□ of product numbers show the item color.

- White — WH
- Beige — BG

**Panasonic**

an extensive line  
for today's lifestyle





Frame

Single Frame



Horizontal 2-Gang Frame



Horizontal 3-Gang Frame



Horizontal 4-Gang Frame



Horizontal 5-Gang Frame



Horizontal 6-Gang Frame



Vertical 2-Gang Frame



Vertical 3-Gang Frame



Vertical 4-Gang Frame



Vertical 5-Gang Frame



Vertical 6-Gang Frame



	Single Frame	Horizontal 2-Gang Frame	Horizontal 3-Gang Frame	Horizontal 4-Gang Frame	Horizontal 5-Gang Frame	Horizontal 6-Gang Frame
White	WMTF0801-2WH	WMTF0802-2WH	WMTF0803-2WH	WMTF0804-2WH	WMTF0805-2WH	WMTF0806-2WH
Beige	WMTF0801-2BG	WMTF0802-2BG	WMTF0803-2BG	WMTF0804-2BG	WMTF0805-2BG	WMTF0806-2BG

	Vertical 2-Gang Frame	Vertical 3-Gang Frame	Vertical 4-Gang Frame	Vertical 5-Gang Frame	Vertical 6-Gang Frame
White	WMTF0812-2WH	WMTF0813-2WH	WMTF0814-2WH	WMTF0815-2WH	WMTF0816-2WH
Beige	WMTF0812-2BG	WMTF0813-2BG	WMTF0814-2BG	WMTF0815-2BG	WMTF0816-2BG

delicacy  
you are  
seeking

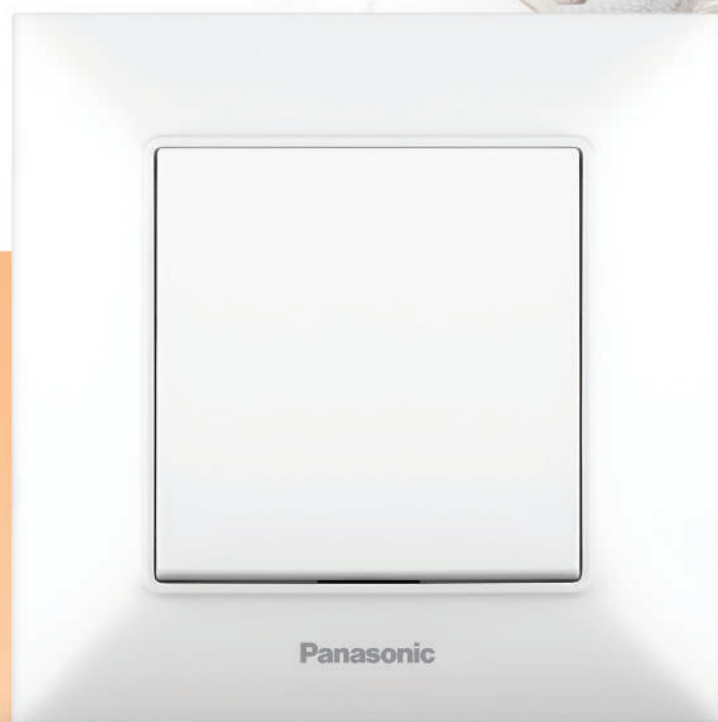

# Panasonic

arkedia  
slim



Arkedia Slim brings delicacy to every living space with its simple and elegant design. With its special form that makes a difference, it offers a more comfortable opening and closing.

# slim and simple design



Based on the concept of human-focused solutions for better and comfortable life, Arkedia Slim is designed with a wide range of product options and color alternatives. Arkedia Slim combines its colors with its modern design and functional products that appeal to subtle pleasures.



# Panasonic



The harmony of subtlety and simplicity is in the fields of life...



arkedia  
slim

Colors

more delicacy and color  
for greater comfort



White



Beige

Arkedia Slim renews the living spaces with its simple and elegant design. Its modern style and its slim form magnify the aesthetic look of Arkedia Slim. "Arkedia Slim" perfectly satisfies your sense of aesthetic with its extraordinary fineness.



# Panasonic



Silver



Bronze

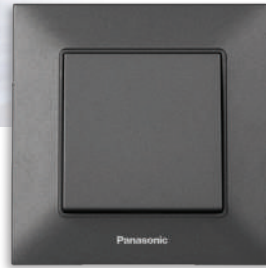

Dark Gray



Black



## Switches (Complete)

**WNTC0001-2** □□

One-way Switch  
10AX, 250V~  
Color ○○



**WNTC0002-2** □□

One-way Switch, Illum.  
10AX, 250V~  
Color ○○



**WNTC0009-2** □□

2-gang One-way Switch  
10AX, 250V~  
Color ○○



**WNTC0010-2** □□

2-gang One-way Switch, Illum.  
10AX, 250V~  
Color ○○



**WNTC0003-2** □□

Two-way Switch  
10AX, 250V~  
Color ○○



**WNTC0004-2** □□

Two-way Switch, Illum.  
10AX, 250V~  
Color ○○



**WNTC0016-2** □□

One-way Push Button  
10AX, 250V~  
Color ○○



**WNTC0017-2** □□

Push Button, Illum.  
10AX, 250V~  
Color ○○



**WNTC0019-2** □□

Push Button with  
Bell Symbol  
10AX, 250V~  
Color ○○



**WNTC0020-2** □□

Push Button with Label,  
Illum. 10AX, 24V~  
Color ○○



**WNTC0018-2** □□

Push Button with  
Key Symbol, Comp.  
10AX, 250V~  
Color ○○



**WNTC0005-2** □□

Intermediate Switch  
10AX, 250V~  
Color ○○



**WNTC0022-2** □□

Shutter Control,  
Push Button  
10AX, 250V~  
Color ○○



**WNTC0011-2** □□

2-gang Two-way Switch  
10AX, 250V~  
Color ○○



**WNTC0012-2** □□

Double One-way Switch  
10AX, 250V~  
Color ○○



**WNTC0013-2** □□

Double One-way  
Push Button  
10AX, 250V~  
Color ○○



**WNTC0043-2** □□

2-pole Switch  
16AX, 250V~  
Color ○○



**WNTC0044-2** □□

2-pole Switch,  
Illum., Comp.  
16AX, 250V~  
Color ○○



**WNTC0015-2** □□

3-gang One-way Switch  
10AX, 250V~  
Color ○○



**WNTC0025-2** □□

Emergency Push  
Button with Cord  
10AX, 250V~  
Color ○○





Sockets (Complete)

WNTC0201-2 □□

Socket 2P  
16A, 250V~  
Color ○ ○



WNTC0211-2 □□

Socket 2P, Safety Shutter  
16A, 250V~  
Color ○ ○



WNTC0202-2 □□

Socket 2P+E  
16A, 250V~  
Color ○ ○



WNTC0212-2 □□

Socket 2P+E, Safety Shutter  
16A, 250V~  
Color ○ ○



WNTC0210-2 □□

Socket 2P+E, Lid and Safety Shutter  
16A, 250V~  
Color ○ ○



WNTC0213-2 □□

Socket 2P+E French, Safety Shutter  
16A, 250V~  
Color ○ ○



WNTC0217-2 □□

Socket 2P+E French,  
Lid and Safety Shutter  
16A, 250V~  
Color ○ ○



WNTC0204-2 □□

Double Socket 2P  
16A, 250V~  
Color ○ ○



WNTC0214-2 □□

Double Socket 2P, Safety Shutter, Comp.  
16A, 250V~  
Color ○ ○



WNTC0205-2 □□

Double Socket 2P+E  
16A, 250V~  
Color ○ ○



WNTC0215-2 □□

Double Socket 2P+E,  
Safety Shutter  
16A, 250V~  
Color ○ ○



WNTC0216-2 □□

Double Socket 2P+E French,  
Safety Shutter  
16A, 250V~  
Color ○ ○



WNTC0231-2 □□

USB Charger Socket 5V-2A  
Color ○ ○

COMING  
SOON



Variety of Colors

White

Beige



The last 2 characters  
in □□ of product numbers  
show the item color.

○ White — WH  
○ Beige — BG

Type of Terminals and Electrical Cables

		Solid Wire	Stranded Wire	Flexible Wire
	Screw Terminal	1.0-2.5mm <sup>2</sup>	1.0-2.5mm <sup>2</sup>	—
	Screw Terminal	1.5-2.5mm <sup>2</sup>	1.5-2.5mm <sup>2</sup>	—

## Switches (Complete)

**WNTC0101-2** □□

One-way Switch  
10AX, 250V~  
Color ○○



**WNTC0102-2** □□

One-way Switch, Illum.  
10AX, 250V~  
Color ○○



**WNTC0109-2** □□

2-gang One-way Switch  
10AX, 250V~  
Color ○○

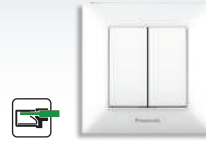

**WNTC0110-2** □□

2-gang One-way Switch, Illum.  
10AX, 250V~  
Color ○○

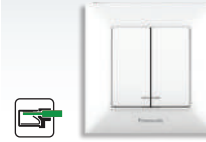

**WNTC0103-2** □□

Two-way Switch  
10AX, 250V~  
Color ○○



**WNTC0104-2** □□

Two-way Switch, Illum.  
10AX, 250V~  
Color ○○



**WNTC0126-2** □□

Two-way Push Button  
10AX, 250V~  
Color ○○



**WNTC0116-2** □□

One-way Push Button  
10AX, 250V~  
Color ○○



**WNTC0117-2** □□

Push Button, Illum.  
10AX, 250V~  
Color ○○



**WNTC0119-2** □□

Push Button with  
Bell Symbol  
10AX, 250V~  
Color ○○



**WNTC0120-2** □□

Push Button with Label,  
Illum. 10AX, 24V~  
Color ○○



**WNTC0118-2** □□

Push Button with  
Key Symbol, Comp.  
10AX, 250V~  
Color ○○



**WNTC0105-2** □□

Intermediate Switch  
10AX, 250V~  
Color ○○



**WNTC0122-2** □□

Shutter Control,  
Push Button  
10AX, 250V~  
Color ○○



**WNTC0111-2** □□

2-gang Two-way Switch  
10AX, 250V~  
Color ○○



**WNTC0112-2** □□

Double One-way Switch  
10AX, 250V~  
Color ○○



**WNTC0113-2** □□

Double One-way  
Push Button  
10AX, 250V~  
Color ○○



**WNTC0127-2** □□

One-way Switch, Illum. with Cont. Light  
10AX, 250V~  
Color ○○



**WNTC0143-2** □□

2-pole Switch  
16AX, 250V~  
Color ○○



**WNTC0144-2** □□

2-pole Switch,  
Illum., Comp.  
16AX, 250V~  
Color ○○



Switches (Complete)

WNTC0125-2 □□

Emergency Push  
Button with Cord  
10AX, 250V~  
Color ○ ○

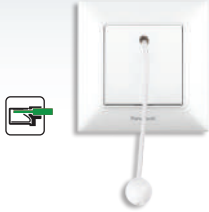

Sockets (Complete)

WNTC0301-2 □□

Socket 2P  
16A, 250V~  
Color ○ ○



WNTC0311-2 □□

Socket 2P, Safety Shutter  
16A, 250V~  
Color ○ ○



WNTC0302-2 □□

Socket 2P+E  
16A, 250V~  
Color ○ ○



WNTC0312-2 □□

Socket 2P+E, Safety Shutter  
16A, 250V~  
Color ○ ○



WNTC0310-2 □□

Socket 2P+E, Lid and Safety Shutter  
16A, 250V~  
Color ○ ○



WNTC0313-2 □□

Socket 2P+E French, Safety Shutter  
16A, 250V~  
Color ○ ○



WNTC0317-2 □□

Socket 2P+E French,  
Lid and Safety Shutter  
16A, 250V~  
Color ○ ○



Dimmers (Complete)

WNTC0520-2 □□

PRO Dimmer RL 6-100W  
Color ○ ○



WNTC0528-2 □□

PRO Dimmer RL 20-500W  
Color ○ ○



WNTC0525-2 □□

Rotary Dimmer RC 40-400W  
230V~  
Color ○ ○



WNTC0524-2 □□

Rotary Dimmer RLC 20-350W  
230V~  
Color ○ ○



WNTC0527-2 □□

Rotary Dimmer 1-10V  
Color ○ ○



Variety of Colors

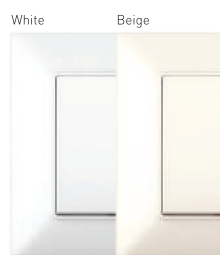

The last 2 characters  
in □□ of product numbers  
show the item color:

- White — WH
- Beige — BG

Type of Terminals and Electrical Cables

	Solid Wire	Stranded Wire	Flexible Wire
Screwless Terminal	1.5-2.5mm <sup>2</sup>	1.5-2.5mm <sup>2</sup>	—

## Telephone and Data Sockets (Complete)

**WNTC0402-2**    
RJ11 CAT3  
Color



**WNTC0404-2**    
RJ45 CAT5E  
Color



**WNTC0405-2**    
RJ45 CAT6  
Color



**WNTC0403-2**    
Double RJ11 CAT3  
Color



**WNTC0406-2**    
Double RJ45 CAT5E  
Color



**WNTC0407-2**    
Double RJ45 CAT6  
Color



Variety of Colors

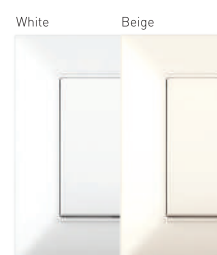

The last 2 characters  
in □□ of product numbers  
show the item color.

- White — WH
- Beige — BG

# Panasonic

the slim design  
you're looking for  
is in Arkeidia Slim...



**White**

**Beige**

**Silver**

**Bronze**

**Dark Gray**

**Black**

	Single Frame	Horizontal 2-Gang Frame	Horizontal 3-Gang Frame	Horizontal 4-Gang Frame	Horizontal 5-Gang Frame	Horizontal 6-Gang Frame
<b>White</b>	WNTF0801-2WH	WNTF0802-2WH	WNTF0803-2WH	WNTF0804-2WH	WNTF0805-2WH	WNTF0806-2WH
<b>Beige</b>	WNTF0801-2BG	WNTF0802-2BG	WNTF0803-2BG	WNTF0804-2BG	WNTF0805-2BG	WNTF0806-2BG
<b>Silver</b>	WNTF0801-2SL	WNTF0802-2SL	WNTF0803-2SL	WNTF0804-2SL	WNTF0805-2SL	WNTF0806-2SL
<b>Bronze</b>	WNTF0801-2BR	WNTF0802-2BR	WNTF0803-2BR	WNTF0804-2BR	WNTF0805-2BR	WNTF0806-2BR
<b>Dark Gray</b>	WNTF0801-2DG	WNTF0802-2DG	WNTF0803-2DG	WNTF0804-2DG	WNTF0805-2DG	WNTF0806-2DG
<b>Black</b>	WNTF0801-2BL	WNTF0802-2BL	WNTF0803-2BL	WNTF0804-2BL	WNTF0805-2BL	WNTF0806-2BL

**Frame**

Single Frame



Horizontal 2-Gang Frame



Vertical 2-Gang Frame



Vertical 3-Gang Frame



Vertical 4-Gang Frame



Vertical 5-Gang Frame



Vertical 6-Gang Frame



Horizontal 3-Gang Frame



Horizontal 4-Gang Frame



Horizontal 5-Gang Frame



Horizontal 6-Gang Frame



Double Socket Frame



	Vertical 2-Gang Frame	Vertical 3-Gang Frame	Vertical 4-Gang Frame	Vertical 5-Gang Frame	Vertical 6-Gang Frame	Double Socket Frame
White	WNTF0812-2WH	WNTF0813-2WH	WNTF0814-2WH	WNTF0815-2WH	WNTF0816-2WH	WNTF0809-2WH
Beige	WNTF0812-2BG	WNTF0813-2BG	WNTF0814-2BG	WNTF0815-2BG	WNTF0816-2BG	WNTF0809-2BG
Silver	WNTF0812-2SL	WNTF0813-2SL	WNTF0814-2SL	WNTF0815-2SL	WNTF0816-2SL	WNTF0809-2SL
Bronze	WNTF0812-2BR	WNTF0813-2BR	WNTF0814-2BR	WNTF0815-2BR	WNTF0816-2BR	WNTF0809-2BR
Dark Gray	WNTF0812-2DG	WNTF0813-2DG	WNTF0814-2DG	WNTF0815-2DG	WNTF0816-2DG	WNTF0809-2DG
Black	WNTF0812-2BL	WNTF0813-2BL	WNTF0814-2BL	WNTF0815-2BL	WNTF0816-2BL	WNTF0809-2BL

elegantly  
tough





# Panasonic

PACIFIC  
IP54



Pacific featuring IP54 meets the user expectations under tough conditions at the utmost level. It comes into prominence with its safe use against dust, water splash, moisture and its aesthetic design.

PACIFIC  
IP54

for tough  
conditions  
**IP54**



- Protection against dust and water splash with IP54 feature
- Labeled and unlabeled product alternatives according to the needs and opportunity to put label when desired
- Patented seal system allowing cable assembly from the closest point of the wall and without bending
- Perfect impermeability with double injection seals allowing cable assembly in three different diameters
- Wide internal volume for easy cable assembly inside the product
- Glass-fibre reinforced thermoplastic material ensuring high impact strength and resistance to chemical and thermal environment

# Panasonic



## IP54



### Superior Design Transparent Label

Pacific facilitates everybody's works with its label area on the switch and sockets. Label area is protected with plastic cover against water and moisture to prevent the removal of the instructions written on this area. Label kit may be purchased separately according to the needs. Pacific responds to the demands of the ones for more usage comfort with illuminated switch options.



Cover providing additional safety



Locking cover to prevent unauthorized usages