

Panasonic



karre plus

fascinating anatomy

Mechanism: Thinness and resistance

Resistant metal frame with a thickness of 1 mm ensures the desired performance during the installation. Extra details added to the metal frames provide help to make the alignment as desired. Assemblies are safely carried out with its specially rolled non-hurting tabs.

Retainer: Strong and durable

Retainer that is designed with an ideal proportion to fasten the button and covers securely meets the expectations for endurance and strength desired during the usage and replacement of covers.

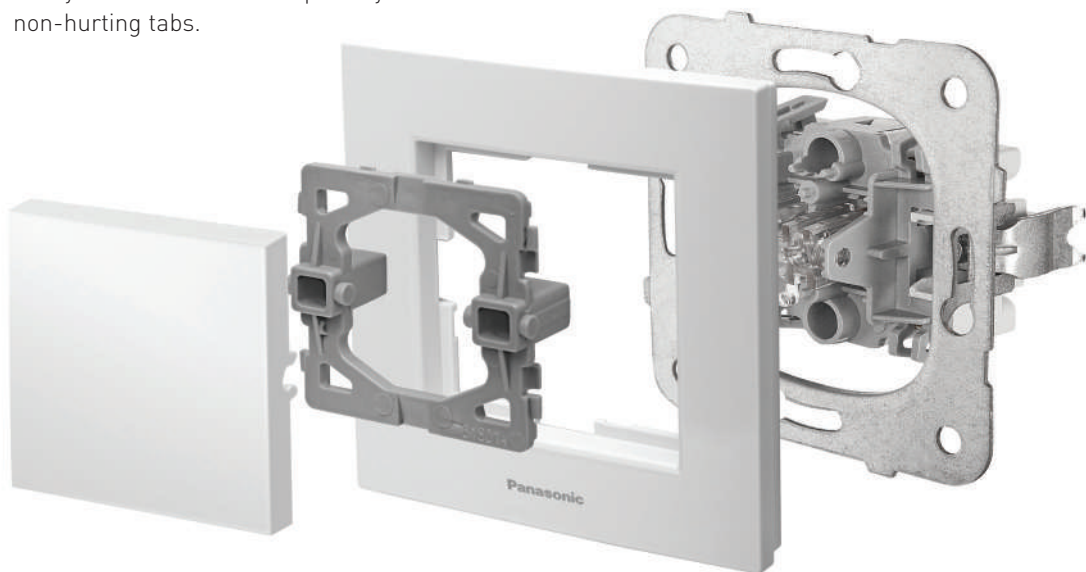

Frame: Chic and modern

Frames in square forms with modern designs having two-unit, three-unit, four-unit, five-unit, six-unit options that can be used vertically and horizontally according to the decorations offer the trends of today in its color alternatives.

Button: Single, double or illuminated options

Replaceable buttons and covers with single, binary or illuminated options are available in different colors.



LED lighting in illuminated switches

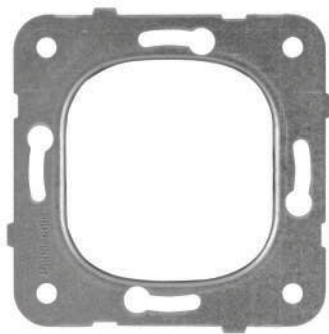

Resistant metal frame with a thickness of 1 mm

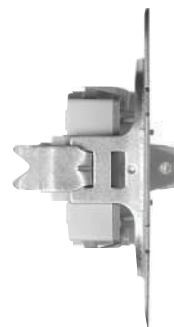

Non-hurting rolled special tab structure

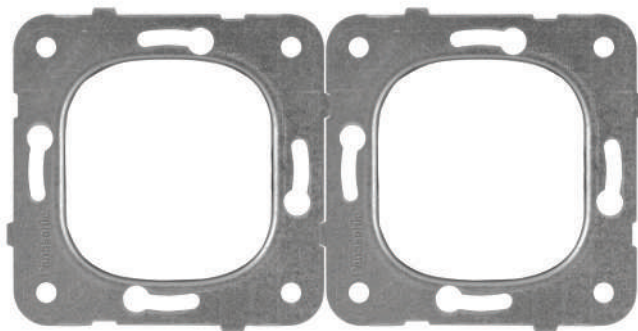

Details assisting the alignment added to the metal frame for perfect assembly

modern choices modern homes



Digital Programmable Shutter Control

Programmable Shutter Control with both daily and weekly programmable digital display having special theft scenario.



Digital Programmable Shutter Control
Graphic LCD display
Easy-to-use menus
Power reserve exceeding 6 hours
Semi-open, open, closed modes
Summer / Winter - 2 separate weeks scheduling feature

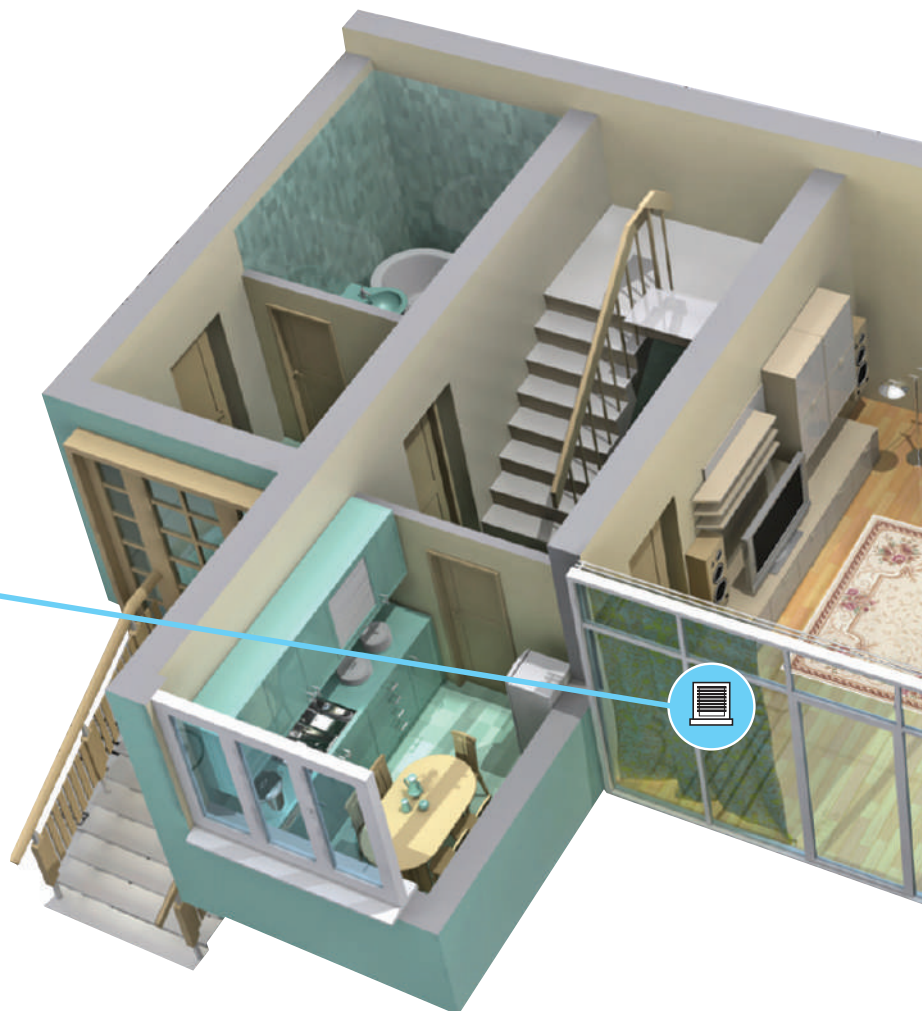



PRO Dimmer Family

Meet new PRO DIMMER offering comfort, coziness and superior protection with its technology and design.



RLC PRO Dimmer
Smart dimmer feature
Overcurrent Protection
Overload protection (thermal)
RLC - 20W - 350W
R,L and C load types

RL PRO Dimmer
Short-Circuit Protection
Overload protection (thermal)
20W -500W, R and L load types
Two-way feature

RC PRO Dimmer
Short-Circuit Protection
Overload protection (thermal) 40W - 400W,
R and C load types
Two-way feature

1-10V Potentiometer
Dims the fluorescent lamps by connecting to the dimmable ballast.
Switching current is 6A

- 4 different models as RL, RC, RLC and 1-10V dimmers according to the lighting types to be used.
- Superior protection against the errors arising from installation and lighting with Over Load and Short Circuit Protection Feature.
- Ease of turning on and off by a single touch thanks to this Push On-Off feature
- Two-way feature in PRO RL and PRO RC series.
- Compliance with all dimmable lamp types with load identification feature in PRO RLC series

Analog and Programmable Digital Thermostat

Temperature setting with high precision thanks to the special PI algorithm! Programmable Digital Thermostat with backlit, user-friendly menu supported by 7 languages.



Analog Thermostat
Temperature setting between 10°C - 30°C
+/- 1°C measurement precision
Warning lamp
Protection against freezing



Programmable Digital Thermostat
Temperature setting between 5°C - 30°C
+/- 1°C measurement precision
Graphic LCD display
Menu to use easily
Power reserve exceeding 6 hours
Outside, at home and night modes
Summer / Winter - 2 separate weeks scheduling feature (weekday, weekend, whole week)
Protection against freezing

Switches (Complete)

WKTC0001-2 □□

One-way Switch
10AX, 250V~
Color ○○



WKTC0002-2 □□

One-way Switch, Illum.
10AX, 250V~
Color ○○



WKTC0009-2 □□

2-gang One-way Switch
10AX, 250V~
Color ○○



WKTC0010-2 □□

2-gang One-way Switch, Illum.
10AX, 250V~
Color ○○



WKTC0003-2 □□

Two-way Switch
10AX, 250V~
Color ○○



WKTC0004-2 □□

Two-way Switch, Illum.
10AX, 250V~
Color ○○



WKTC0016-2 □□

One-way Push Button
10AX, 250V~
Color ○○



WKTC0017-2 □□

Push Button, Illum.
10AX, 250V~
Color ○○



WKTC0019-2 □□

Push Button with
Bell Symbol
10AX, 250V~
Color ○○



WKTC0020-2 □□

Push Button w Label,
Illum. 10AX, 24V~
Color ○○



WKTC0018-2 □□

Push Button with
Key Symbol, 10AX, 250V~
Color ○○



WKTC0005-2 □□

Intermediate Switch
10AX, 250V~
Color ○○



WKTC0022-2 □□

Shutter Control,
Push Button
10AX, 250V~
Color ○○



WKTC0011-2 □□

2-gang Two-way Switch
10AX, 250V~
Color ○○



WKTC0012-2 □□

Double One-way Switch
10AX, 250V~
Color ○○



WKTC0013-2 □□

Double One-way
Push Button
10AX, 250V~
Color ○○



WKTC0043-2 □□

2-pole Switch
16AX, 250V~
Color ○○



WKTC0044-2 □□

2-pole Switch, Illum.,
16AX, 250V~
Color ○○



WKTC0015-2 □□

3-gang One-way Switch
10AX, 250V~
Color ○○



WKTC0025-2 □□

Emergency Push
Button with Cord
10AX, 250V~
Color ○○



Sockets (Complete)

WKTC0201-2 □□
 Socket 2P
 16A, 250V~
 Color ○ ○



WKTC0211-2 □□
 Socket 2P, Safety Shutter
 16A, 250V~
 Color ○ ○



WKTC0202-2 □□
 Socket 2P+E
 16A, 250V~
 Color ○ ○



WKTC0212-2 □□
 Socket 2P+E, Safety Shutter
 16A, 250V~
 Color ○ ○



WKTC0210-2 □□
 Socket 2P+E, Lid and Safety Shutter
 16A, 250V~
 Color ○ ○



WKTC0213-2 □□
 Socket 2P+E French, Safety Shutter
 16A, 250V~
 Color ○ ○



WKTC0217-2 □□
 Socket 2P+E French,
 Lid and Safety Shutter
 16A, 250V~
 Color ○ ○



WKTC0204-2 □□
 Double Socket 2P
 16A, 250V~
 Color ○ ○



WKTC0214-2 □□
 Double Socket 2P, Safety Shutter, Comp.
 16A, 250V~
 Color ○ ○



WKTC0205-2 □□
 Double Socket 2P+E
 16A, 250V~
 Color ○ ○





WKTC0215-2 □□
 Double Socket 2P+E,
 Safety Shutter
 16A, 250V~
 Color ○ ○



WKTC0216-2 □□
 Double Socket 2P+E French,
 Safety Shutter
 16A, 250V~
 Color ○ ○



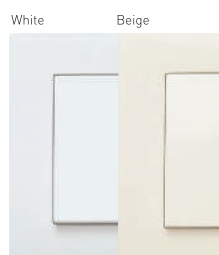

Variety of Colors



The last 2 characters in □□ of product numbers show the item color.

- White — WH
- Beige — BG

Type of Terminals and Electrical Cables

	Solid Wire	Stranded Wire	Flexible Wire
 Screw Terminal	1.0-2.5mm ²	1.0-2.5mm ²	—
 Screw Terminal	1.5-2.5mm ²	1.5-2.5mm ²	—

Dimmers (Complete)

WKTC0525-2 □ □
 Rotary Dimmer RC 40-400W
 230V~
 Color ○ ○



WKTC0524-2 □ □
 Rotary Dimmer RLC 20-350W
 230V~
 Color ○ ○



WKTC0527-2 □ □
 Rotary Dimmer 1-10V
 Color ○ ○



Telephone and Data Sockets (Complete)

WKTC0402-2 □ □
 RJ11 CAT3
 Color



WKTC0404-2 □ □
 RJ45 CAT5E
 Color ○ ○



WKTC0405-2 □ □
 RJ45 CAT6
 Color ○ ○



WKTC0403-2 □ □
 Double RJ11 CAT3
 Color ○ ○



WKTC0406-2 □ □
 Double RJ45 CAT5E
 Color ○ ○



WKTC0407-2 □ □
 Double RJ45 CAT6
 Color ○ ○



WKTC0408-2 □ □
 RJ45 CAT5E + RJ11 CAT3
 Color ○ ○



WKTC0409-2 □ □
 RJ45 CAT6 + RJ11 CAT3
 Color ○ ○



Television Sockets (Complete)

WKTC0412-2 □ □
 Double Keystone Socket
 w/o conn.
 Color ○ ○



WKTC0451-2 □ □
 TV Socket, Terminated
 Color ○ ○



WKTC0452-2 □ □
 TV Socket, Thr.-pass (12dB)
 Color ○ ○



WKTC0454-2 □ □
 TV Socket, Lossless
 Color ○ ○



WKTC0458-2 □ □
 SAT Socket, Terminated
 Color ○ ○



WKTC0459-2 □ □
 SAT Socket, Thr.-pass (10dB)
 Color ○ ○



WKTC0460-2 □ □
 TV-SAT Socket,
 Terminated
 Color ○ ○



WKTC0461-2 □ □
 TV-SAT Socket, Thr.-pass (11dB)
 Color ○ ○



Telephone and Data Sockets (Complete)

WKTC0463-2 □□
TV-RAD-SAT Socket,
Terminated
Color ○○



WKTC0466-2 □□
SAT-SAT-TV Socket,
Terminated
Color ○○



Audio Control and Audio Socket (Complete)

WKTC0561-2 □□
Volume Control Switch
Color ○○



WKTC0563-2 □□
Audio Channel
Selection Switch
Color ○○



Accessories (Complete)

WKTC0560-2 □□
Audio Socket
Color ○○



WKTC0702-2 □□
Cable Outlet
Color ○○



WKTC0701-2 □□
Blank Cover
Color ○○



WKTC0791-9 □□
Surface Mounting Box, Single
Color ○○



WKTC0792-9 □□
Surface Mounting Box, Double
Color ○○



WKTC0712-4NC
IP44 Gasket Kit for Switch



WKTC0713-4NC
IP44 Gasket Kit for
2-gang Switch



WKTC0711-4NC
IP44 Gasket Kit for Socket
with Lid



Variety of Colors

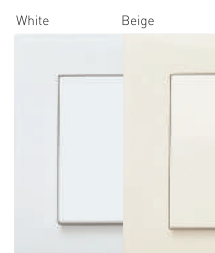

The last 2 characters in □□ of product numbers show the item color.

- White — WH
- Beige — BG

Switches (Mechanism + Rocker)

WKTT0001-2 □□

One-way Switch
10AX, 250V~
Color ○ ○ ○ ○ ● ●



WKTT0002-2 □□

One-way Switch, Illum.
10AX, 250V~
Color ○ ○ ○ ○ ● ●



WKTT0009-2 □□

2-gang One-way Switch
10AX, 250V~
Color ○ ○ ○ ○ ● ●



WKTT0010-2 □□

2-gang One-way Switch, Illum.
10AX, 250V~
Color ○ ○ ○ ○ ● ●

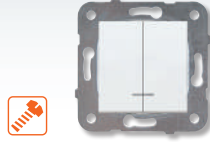

WKTT0003-2 □□

Two-way Switch
10AX, 250V~
Color ○ ○ ○ ○ ● ●



WKTT0004-2 □□

Two-way Switch, Illum.
10AX, 250V~
Color ○ ○ ○ ○ ● ●



WKTT0016-2 □□

One-way Push Button
10AX, 250V~
Color ○ ○ ○ ○ ● ●



WKTT0017-2 □□

Push Button, Illum.
10AX, 250V~
Color ○ ○ ○ ○ ● ●

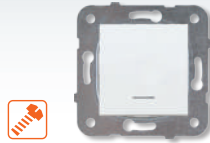

WKTT0019-2 □□

Push Button w Bell Symbol
10AX, 250V~
Color ○ ○ ○ ○ ● ●



WKTT0020-2 □□

Push Button w Label, Illum.
10AX, 24V~
Color ○ ○ ○ ○ ● ●



WKTT0018-2 □□

Push Button with Key Symbol,
Comp10AX, 250V~
Color ○ ○ ○ ○ ● ●



WKTT0005-2 □□

Intermediate Switch
10AX, 250V~
Color ○ ○ ○ ○ ● ●



WKTT0022-2 □□

Shutter Control, Push Button
10AX, 250V~
Color ○ ○ ○ ○ ● ●



WKTT0011-2 □□

2-gang Two-way Switch
10AX, 250V~
Color ○ ○ ○ ○ ● ●



WKTT0012-2 □□

Double One-way Switch
10AX, 250V~
Color ○ ○ ○ ○ ● ●

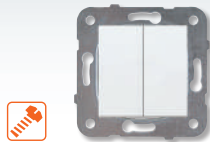

WKTT0013-2 □□

Double One-way Push Button
10AX, 250V~
Color ○ ○ ○ ○ ● ●



WKTT0043-2 □□

2-pole Switch
16AX, 250V~
Color ○ ○ ○ ○ ● ●



WKTT0044-2 □□

2-pole Switch, Illum., Comp.
16AX, 250V~
Color ○ ○ ○ ○ ● ●



WKTT0015-2 □□

3-gang One-way Switch
10AX, 250V~
Color ○ ○ ○ ○ ● ●



WKTT0025-2 □□

Emergency Push Button w Cord
10AX, 250V~
Color ○ ○ ○ ○ ● ●



Sockets (Mechanism + Cover Plate)

<p>WKTT0201-2 □□</p> <p>Socket 2P 16A, 250V~ Color ○ ○ ○ ○ ○ ●</p>  	<p>WKTT0211-2 □□</p> <p>Socket 2P, Safety Shutter 16A, 250V~ Color ○ ○ ○ ○ ○ ●</p>  	<p>WKTT0202-2 □□</p> <p>Socket 2P+E 16A, 250V~ Color ○ ○ ○ ○ ○ ●</p>  	<p>WKTT0212-2 □□</p> <p>Socket 2P+E, Safety Shutter 16A, 250V~ Color ○ ○ ○ ○ ○ ●</p>  
<p>WKTT0210-2 □□</p> <p>Socket 2P+E, Lid and Safety Shutter 16A, 250V~ Color ○ ○ ○ ○ ○ ●</p>  	<p>WKTT0213-2 □□</p> <p>Socket 2P+E French, Safety Shutter 16A, 250V~ Color ○ ○ ○ ○ ○ ●</p>  	<p>WKTT0217-2 □□</p> <p>Socket 2P+E French, Lid and Safety Shutter 16A, 250V~ Color ○ ○ ○ ○ ○ ●</p>  	<p>WKTT0204-2 □□</p> <p>Double Socket 2P 16A, 250V~ Color ○ ○ ○ ○ ○ ●</p>  
<p>WKTT0214-2 □□</p> <p>Double Socket 2P, Safety Shutter, Comp. 16A, 250V~ Color ○ ○ ○ ○ ○ ●</p>  	<p>WKTT0205-2 □□</p> <p>Double Socket 2P+E 16A, 250V~ Color ○ ○ ○ ○ ○ ●</p>  	<p>WKTT0215-2 □□</p> <p>Double Socket 2P+E, Safety Shutter 16A, 250V~ Color ○ ○ ○ ○ ○ ●</p>  	<p>WKTT0216-2 □□</p> <p>Double Socket 2P+E French, Safety Shutter 16A, 250V~ Color ○ ○ ○ ○ ○ ●</p>  

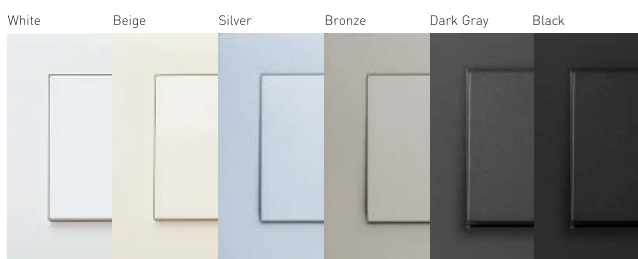

Variety of Colors



The last 2 characters in □□ of product numbers show the item color.

- White — WH
- Beige — BG
- Silver — SL
- Bronze — BR
- Dark Gray — DG
- Black — BL

Type of Terminals and Electrical Cables

	Solid Wire	Stranded Wire	Flexible Wire
 Screw Terminal	1.0-2.5mm ²	1.0-2.5mm ²	—
 Screw Terminal	1.5-2.5mm ²	1.5-2.5mm ²	—

Dimmers (Mechanism + Cover Plate)

WKTT0525-2 □ □
 Rotary Dimmer RC 40-400W
 230V-
 Color ○ ○ ○ ○ ○ ● ●



WKTT0524-2 □ □
 Rotary Dimmer RLC 20-350W
 230V-
 Color ○ ○ ○ ○ ○ ● ●



WKTT0527-2 □ □
 Rotary Dimmer 1-10V
 Color ○ ○ ○ ○ ○ ● ●



Telephone and Data Sockets (Mechanism + Cover Plate)

WKTT0402-2 □ □
 RJ11 CAT3
 Color ○ ○ ○ ○ ○ ● ●



WKTT0404-2 □ □
 RJ45 CAT5E
 Color ○ ○ ○ ○ ○ ● ●



WKTT0405-2 □ □
 RJ45 CAT6
 Color ○ ○ ○ ○ ○ ● ●



WKTT0403-2 □ □
 Double RJ11 CAT3
 Color ○ ○ ○ ○ ○ ● ●



WKTT0406-2 □ □
 Double RJ45 CAT5E
 Color ○ ○ ○ ○ ○ ● ●



WKTT0407-2 □ □
 Double RJ45 CAT6
 Color ○ ○ ○ ○ ○ ● ●



WKTT0408-2 □ □
 RJ45 CAT5E + RJ11 CAT3
 Color ○ ○ ○ ○ ○ ● ●



WKTT0409-2 □ □
 RJ45 CAT6 + RJ11 CAT3
 Color ○ ○ ○ ○ ○ ● ●



Television Sockets (Mechanism + Cover Plate)

WKTT0412-2 □ □
 Double Keystone
 Socket w/o connector
 Color ○ ○ ○ ○ ○ ● ●



WKTT0451-2 □ □
 TV Socket, Terminated
 Color ○ ○ ○ ○ ○ ● ●



WKTT0452-2 □ □
 TV Socket, Thr.-pass (12dB)
 Color ○ ○ ○ ○ ○ ● ●



WKTT0454-2 □ □
 TV Socket, Lossless
 Color ○ ○ ○ ○ ○ ● ●



WKTT0458-2 □ □
 SAT Socket, Terminated
 Color ○ ○ ○ ○ ○ ● ●



WKTT0459-2 □ □
 SAT Socket, Thr.-pass (10dB)
 Color ○ ○ ○ ○ ○ ● ●



WKTT0460-2 □ □
 TV-SAT Socket,
 Terminated
 Color ○ ○ ○ ○ ○ ● ●



WKTT0461-2 □ □
 TV-SAT Socket, Thr.-pass (11dB)
 Color ○ ○ ○ ○ ○ ● ●



Television Sockets (Mechanism + Cover Plate)

WKTT0463-2 □□
TV-RAD-SAT Socket,
Terminated
Color ○ ● ○ ● ○ ● ○ ●

WKTT0466-2 □□
SAT-SAT-TV Socket,
Terminated
Color ○ ● ○ ● ○ ● ○ ●

Audio Control and Audio Socket (Mechanism + Cover Plate)

WKTT0561-2 □□
Volume Control Switch
Color ○ ● ○ ● ○ ● ○ ●

WKTT0563-2 □□
Audio Channel Selection Switch
Color ○ ● ○ ● ○ ● ○ ●

Thermostats (Mechanism + Cover Plate)

WKTT0560-2 □□
Audio Socket
Color ○ ● ○ ● ○ ● ○ ●

WKTT0541-5 □□
Room Thermostat
Color ○ ● ○ ● ○ ● ○ ●

WKTT0542-5 □□
Program. Room Thermostat
Color ○ ● ○ ● ○ ● ○ ●

Shutter Control (Mechanism + Cover Plate)

WKTT0543-5 □□
Program. Shutter Control
Color ○ ● ○ ● ○ ● ○ ●

Cable Outlet and Blank Covers (Mechanism + Cover Plate)

WKTT0702-2 □□
Cable Outlet
Color ○ ● ○ ● ○ ● ○ ●

WKTT0701-2 □□
Blank Cover
Color ○ ● ○ ● ○ ● ○ ●

Variety of Colors

White Beige Silver Bronze Dark Gray Black

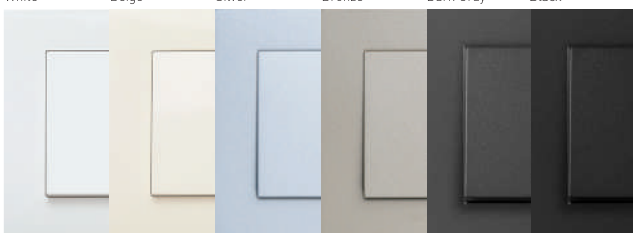

The last 2 characters in □□ of product numbers show the item color.

- White — WH
- Beige — BG
- Silver — SL
- Bronze — BR
- Dark Gray — DG
- Black — BL

Frame

Single Frame



Horizontal 2-Gang Frame



Horizontal 3-Gang Frame



Horizontal 4-Gang Frame



Horizontal 5-Gang Frame



Horizontal 6-Gang Frame



	Single Frame	Horizontal 2-Gang Frame	Horizontal 3-Gang Frame	Horizontal 4-Gang Frame	Horizontal 5-Gang Frame	Horizontal 6-Gang Frame
White	WKTF0801-2WH	WKTF0802-2WH	WKTF0803-2WH	WKTF0804-2WH	WKTF0805-2WH	WKTF0806-2WH
Beige	WKTF0801-2BG	WKTF0802-2BG	WKTF0803-2BG	WKTF0804-2BG	WKTF0805-2BG	WKTF0806-2BG
Silver	WKTF0801-2SL	WKTF0802-2SL	WKTF0803-2SL	WKTF0804-2SL	WKTF0805-2SL	WKTF0806-2SL
Bronze	WKTF0801-2BR	WKTF0802-2BR	WKTF0803-2BR	WKTF0804-2BR	WKTF0805-2BR	WKTF0806-2BR
Dark Gray	WKTF0801-2DG	WKTF0802-2DG	WKTF0803-2DG	WKTF0804-2DG	WKTF0805-2DG	WKTF0806-2DG
Black	WKTF0801-2BL	WKTF0802-2BL	WKTF0803-2BL	WKTF0804-2BL	–	–
Aluminum Silver	WKTF0801-3AS	WKTF0802-3AS	WKTF0803-3AS	WKTF0804-3AS	–	–
Aluminum Bronze	WKTF0801-3AR	WKTF0802-3AR	WKTF0803-3AR	WKTF0804-3AR	–	–
Aluminum Black	WKTF0801-3AB	WKTF0802-3AB	WKTF0803-3AB	WKTF0804-3AB	–	–
Wooden Oak	WKTF0801-3WO	WKTF0802-3WO	WKTF0803-3WO	WKTF0804-3WO	–	–
Wooden Cherry	WKTF0801-3WK	WKTF0802-3WK	WKTF0803-3WK	WKTF0804-3WK	–	–
Wooden Walnut	WKTF0801-3WW	WKTF0802-3WW	WKTF0803-3WW	WKTF0804-3WW	–	–
Corian Sandstone	WKTF0801-3CS	WKTF0802-3CS	WKTF0803-3CS	WKTF0804-3CS	–	–
Corian Dusk	WKTF0801-3CD	WKTF0802-3CD	WKTF0803-3CD	WKTF0804-3CD	–	–
Corian Blackquartz	WKTF0801-3CB	WKTF0802-3CB	WKTF0803-3CB	WKTF0804-3CB	–	–
Glass Light Green	WKTF0801-3GG	WKTF0802-3GG	WKTF0803-3GG	WKTF0804-3GG	–	–
Glass Claret Red	WKTF0801-3GC	WKTF0802-3GC	WKTF0803-3GC	WKTF0804-3GC	–	–
Glass Black	WKTF0801-3GB	WKTF0802-3GB	WKTF0803-3GB	WKTF0804-3GB	–	–

Variety of Colors

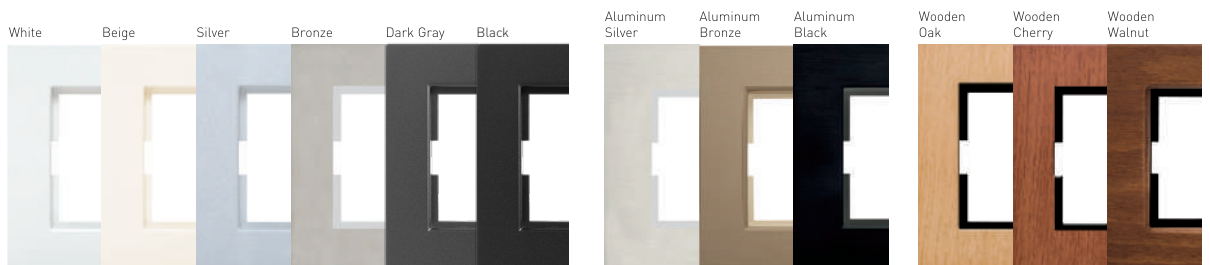

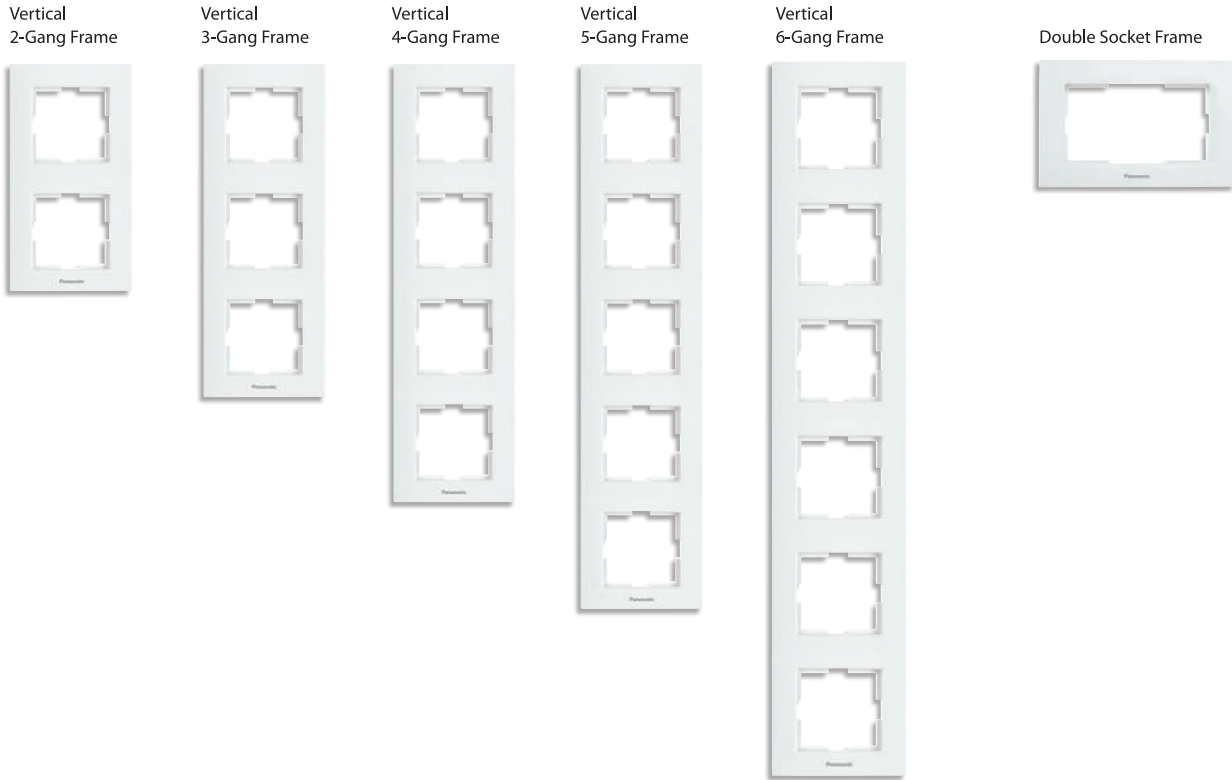

	Vertical 2-Gang Frame	Vertical 3-Gang Frame	Vertical 4-Gang Frame	Vertical 5-Gang Frame	Vertical 6-Gang Frame	Double Socket Frame
White	WKTF0812-2WH	WKTF0813-2WH	WKTF0814-2WH	WKTF0815-2WH	WKTF0816-2WH	WKTF0809-2WH
Beige	WKTF0812-2BG	WKTF0813-2BG	WKTF0814-2BG	WKTF0815-2BG	WKTF0816-2BG	WKTF0809-2BG
Silver	WKTF0812-2SL	WKTF0813-2SL	WKTF0814-2SL	WKTF0815-2SL	WKTF0816-2SL	WKTF0809-2SL
Bronze	WKTF0812-2BR	WKTF0813-2BR	WKTF0814-2BR	WKTF0815-2BR	WKTF0816-2BR	WKTF0809-2BR
Dark Gray	WKTF0812-2DG	WKTF0813-2DG	WKTF0814-2DG	WKTF0815-2DG	WKTF0816-2DG	WKTF0809-2DG
Black	WKTF0812-2BL	WKTF0813-2BL	WKTF0814-2BL	–	–	–
Aluminum Silver	WKTF0812-3AS	WKTF0813-3AS	WKTF0814-3AS	–	–	WKTF0809-3AS
Aluminum Bronze	WKTF0812-3AR	WKTF0813-3AR	WKTF0814-3AR	–	–	WKTF0809-3AR
Aluminum Black	WKTF0812-3AB	WKTF0813-3AB	WKTF0814-3AB	–	–	WKTF0809-3AB
Wooden Oak	WKTF0812-3WO	WKTF0813-3WO	WKTF0814-3WO	–	–	WKTF0809-3WO
Wooden Cherry	WKTF0812-3WK	WKTF0813-3WK	WKTF0814-3WK	–	–	WKTF0809-3WK
Wooden Walnut	WKTF0812-3WW	WKTF0813-3WW	WKTF0814-3WW	–	–	WKTF0809-3WW
Corian Sandstone	WKTF0812-3CS	WKTF0813-3CS	WKTF0814-3CS	–	–	WKTF0809-3CS
Corian Dusk	WKTF0812-3CD	WKTF0813-3CD	WKTF0814-3CD	–	–	WKTF0809-3CD
Corian Blackquartz	WKTF0812-3CB	WKTF0813-3CB	WKTF0814-3CB	–	–	WKTF0809-3CB
Glass Light Green	WKTF0812-3GG	WKTF0813-3GG	WKTF0814-3GG	–	–	WKTF0809-3GG
Glass Claret Red	WKTF0812-3GC	WKTF0813-3GC	WKTF0814-3GC	–	–	WKTF0809-3GC
Glass Black	WKTF0812-3GB	WKTF0813-3GB	WKTF0814-3GB	–	–	WKTF0809-3GB

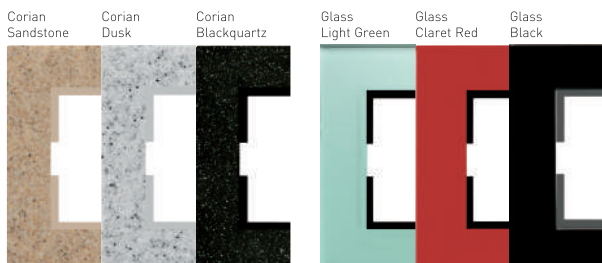

delicacy
you are
seeking



Panasonic

arkedia
slim



Arkedia Slim brings delicacy to every living space with its simple and elegant design. With its special form that makes a difference, it offers a more comfortable opening and closing.

slim and simple design



Based on the concept of human-focused solutions for better and comfortable life, Arkedia Slim is designed with a wide range of product options and color alternatives. Arkedia Slim combines its colors with its modern design and functional products that appeal to subtle pleasures.



Panasonic



The harmony of subtlety and simplicity is in the fields of life...



arkedia
slim

Colors

more delicacy and color
for greater comfort



White



Beige

Arkedia Slim renews the living spaces with its simple and elegant design. Its modern style and its slim form magnify the aesthetic look of Arkedia Slim. "Arkedia Slim" perfectly satisfies your sense of aesthetic with its extraordinary fineness.



Panasonic



Silver



Bronze



Dark Gray



Black



Switches (Complete)

WNTC0001-2 □□

One-way Switch
10AX, 250V~
Color ○○



WNTC0002-2 □□

One-way Switch, Illum.
10AX, 250V~
Color ○○



WNTC0009-2 □□

2-gang One-way Switch
10AX, 250V~
Color ○○



WNTC0010-2 □□

2-gang One-way Switch, Illum.
10AX, 250V~
Color ○○



WNTC0003-2 □□

Two-way Switch
10AX, 250V~
Color ○○



WNTC0004-2 □□

Two-way Switch, Illum.
10AX, 250V~
Color ○○



WNTC0016-2 □□

One-way Push Button
10AX, 250V~
Color ○○



WNTC0017-2 □□

Push Button, Illum.
10AX, 250V~
Color ○○



WNTC0019-2 □□

Push Button with
Bell Symbol
10AX, 250V~
Color ○○



WNTC0020-2 □□

Push Button with Label,
Illum. 10AX, 24V~
Color ○○



WNTC0018-2 □□

Push Button with
Key Symbol, Comp.
10AX, 250V~
Color ○○



WNTC0005-2 □□

Intermediate Switch
10AX, 250V~
Color ○○



WNTC0022-2 □□

Shutter Control,
Push Button
10AX, 250V~
Color ○○



WNTC0011-2 □□

2-gang Two-way Switch
10AX, 250V~
Color ○○



WNTC0012-2 □□

Double One-way Switch
10AX, 250V~
Color ○○



WNTC0013-2 □□

Double One-way
Push Button
10AX, 250V~
Color ○○



WNTC0043-2 □□

2-pole Switch
16AX, 250V~
Color ○○



WNTC0044-2 □□

2-pole Switch,
Illum., Comp.
16AX, 250V~
Color ○○



WNTC0015-2 □□

3-gang One-way Switch
10AX, 250V~
Color ○○



WNTC0025-2 □□

Emergency Push
Button with Cord
10AX, 250V~
Color ○○



Sockets (Complete)

WNTC0201-2 □□

Socket 2P
16A, 250V~
Color ○ ○



WNTC0211-2 □□

Socket 2P, Safety Shutter
16A, 250V~
Color ○ ○



WNTC0202-2 □□

Socket 2P+E
16A, 250V~
Color ○ ○



WNTC0212-2 □□

Socket 2P+E, Safety Shutter
16A, 250V~
Color ○ ○



WNTC0210-2 □□

Socket 2P+E, Lid and Safety Shutter
16A, 250V~
Color ○ ○



WNTC0213-2 □□

Socket 2P+E French, Safety Shutter
16A, 250V~
Color ○ ○



WNTC0217-2 □□

Socket 2P+E French,
Lid and Safety Shutter
16A, 250V~
Color ○ ○



WNTC0204-2 □□

Double Socket 2P
16A, 250V~
Color ○ ○



WNTC0214-2 □□

Double Socket 2P, Safety Shutter, Comp.
16A, 250V~
Color ○ ○



WNTC0205-2 □□

Double Socket 2P+E
16A, 250V~
Color ○ ○



WNTC0215-2 □□

Double Socket 2P+E,
Safety Shutter
16A, 250V~
Color ○ ○



WNTC0216-2 □□

Double Socket 2P+E French,
Safety Shutter
16A, 250V~
Color ○ ○



WNTC0231-2 □□

USB Charger Socket 5V-2A
Color ○ ○

COMING SOON



Variety of Colors

White Beige



The last 2 characters in □□ of product numbers show the item color.

○ White — WH
○ Beige — BG

Type of Terminals and Electrical Cables

		Solid Wire	Stranded Wire	Flexible Wire
	Screw Terminal	1.0-2.5mm ²	1.0-2.5mm ²	—
	Screw Terminal	1.5-2.5mm ²	1.5-2.5mm ²	—

Switches (Complete)

WNTC0101-2 □□

One-way Switch
10AX, 250V~
Color ○○



WNTC0102-2 □□

One-way Switch, Illum.
10AX, 250V~
Color ○○



WNTC0109-2 □□

2-gang One-way Switch
10AX, 250V~
Color ○○



WNTC0110-2 □□

2-gang One-way Switch, Illum.
10AX, 250V~
Color ○○

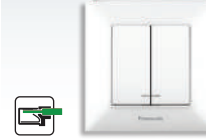

WNTC0103-2 □□

Two-way Switch
10AX, 250V~
Color ○○



WNTC0104-2 □□

Two-way Switch, Illum.
10AX, 250V~
Color ○○



WNTC0126-2 □□

Two-way Push Button
10AX, 250V~
Color ○○



WNTC0116-2 □□

One-way Push Button
10AX, 250V~
Color ○○



WNTC0117-2 □□

Push Button, Illum.
10AX, 250V~
Color ○○



WNTC0119-2 □□

Push Button with
Bell Symbol
10AX, 250V~
Color ○○



WNTC0120-2 □□

Push Button with Label,
Illum. 10AX, 24V~
Color ○○



WNTC0118-2 □□

Push Button with
Key Symbol, Comp.
10AX, 250V~
Color ○○



WNTC0105-2 □□

Intermediate Switch
10AX, 250V~
Color ○○



WNTC0122-2 □□

Shutter Control,
Push Button
10AX, 250V~
Color ○○



WNTC0111-2 □□

2-gang Two-way Switch
10AX, 250V~
Color ○○



WNTC0112-2 □□

Double One-way Switch
10AX, 250V~
Color ○○



WNTC0113-2 □□

Double One-way
Push Button
10AX, 250V~
Color ○○



WNTC0127-2 □□

One-way Switch, Illum. with Cont. Light
10AX, 250V~
Color ○○



WNTC0143-2 □□

2-pole Switch
16AX, 250V~
Color ○○



WNTC0144-2 □□

2-pole Switch,
Illum., Comp.
16AX, 250V~
Color ○○



Switches (Complete)

WNTC0125-2 □□

Emergency Push
Button with Cord
10AX, 250V~
Color ○ ○

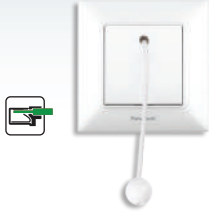

Sockets (Complete)

WNTC0301-2 □□

Socket 2P
16A, 250V~
Color ○ ○



WNTC0311-2 □□

Socket 2P, Safety Shutter
16A, 250V~
Color ○ ○



WNTC0302-2 □□

Socket 2P+E
16A, 250V~
Color ○ ○



WNTC0312-2 □□

Socket 2P+E, Safety Shutter
16A, 250V~
Color ○ ○



WNTC0310-2 □□

Socket 2P+E, Lid and Safety Shutter
16A, 250V~
Color ○ ○



WNTC0313-2 □□

Socket 2P+E French, Safety Shutter
16A, 250V~
Color ○ ○



WNTC0317-2 □□

Socket 2P+E French,
Lid and Safety Shutter
16A, 250V~
Color ○ ○



Dimmers (Complete)

WNTC0520-2 □□

PRO Dimmer RL 6-100W
Color ○ ○



WNTC0528-2 □□

PRO Dimmer RL 20-500W
Color ○ ○



WNTC0525-2 □□

Rotary Dimmer RC 40-400W
230V~
Color ○ ○



WNTC0524-2 □□

Rotary Dimmer RLC 20-350W
230V~
Color ○ ○



WNTC0527-2 □□

Rotary Dimmer 1-10V
Color ○ ○



Variety of Colors

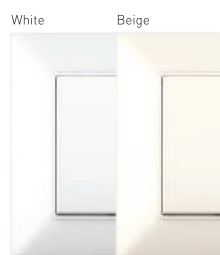

The last 2 characters
in □□ of product numbers
show the item color:

- White — WH
- Beige — BG

Type of Terminals and Electrical Cables

	Solid Wire	Stranded Wire	Flexible Wire
Screwless Terminal	1.5-2.5mm ²	1.5-2.5mm ²	—

Telephone and Data Sockets (Complete)

WNTC0402-2 □ □
RJ11 CAT3
Color ○ ○



WNTC0404-2 □ □
RJ45 CAT5E
Color ○ ○



WNTC0405-2 □ □
RJ45 CAT6
Color ○ ○



WNTC0403-2 □ □
Double RJ11 CAT3
Color ○ ○



WNTC0406-2 □ □
Double RJ45 CAT5E
Color ○ ○



WNTC0407-2 □ □
Double RJ45 CAT6
Color ○ ○



Variety of Colors

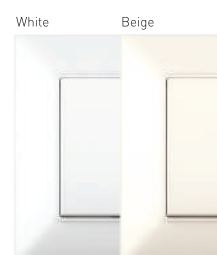

The last 2 characters
in of product numbers
show the item color.

- White — WH
- Beige — BG

Panasonic

the slim design
you're looking for
is in Arkeidia Slim...



White

Beige

Silver

Bronze

Dark Gray

Black

	Single Frame	Horizontal 2-Gang Frame	Horizontal 3-Gang Frame	Horizontal 4-Gang Frame	Horizontal 5-Gang Frame	Horizontal 6-Gang Frame
White	WNTF0801-2WH	WNTF0802-2WH	WNTF0803-2WH	WNTF0804-2WH	WNTF0805-2WH	WNTF0806-2WH
Beige	WNTF0801-2BG	WNTF0802-2BG	WNTF0803-2BG	WNTF0804-2BG	WNTF0805-2BG	WNTF0806-2BG
Silver	WNTF0801-2SL	WNTF0802-2SL	WNTF0803-2SL	WNTF0804-2SL	WNTF0805-2SL	WNTF0806-2SL
Bronze	WNTF0801-2BR	WNTF0802-2BR	WNTF0803-2BR	WNTF0804-2BR	WNTF0805-2BR	WNTF0806-2BR
Dark Gray	WNTF0801-2DG	WNTF0802-2DG	WNTF0803-2DG	WNTF0804-2DG	WNTF0805-2DG	WNTF0806-2DG
Black	WNTF0801-2BL	WNTF0802-2BL	WNTF0803-2BL	WNTF0804-2BL	WNTF0805-2BL	WNTF0806-2BL