

PRODUCT DATA SHEET

V:KO
by **Panasonic**

Product Name :	Vera White Illuminated Switch + 2P Socket
Product Code :	90681190
Product Series :	Vera
Technical Specifications :	
<i>Rated Current :</i>	16AX, 250V~ (Socket) / 10AX, 250V~(Switch)
<i>Terminal Type :</i>	Screw Terminal
Materials :	
<i>Outer Body :</i>	Glass-Fibre reinforced PP
<i>Rocker :</i>	ABS
<i>Mechanism :</i>	PC
Certifications :	TSE, VDE, NF, EAC, CE
Cable Standard:	
<i>Cable Diameter :</i>	1mm ² -2,5mm ²
<i>Applicable Cable:</i>	Solid Wire, Stranded Wire
IP Degree:	IP20



Screw
Terminal

Circuit Diagram:

Circuit Diagram for Switch

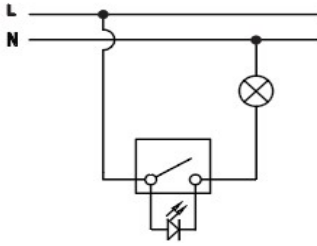

Circuit Diagram for Socket

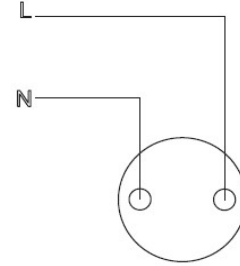

Dimensions:

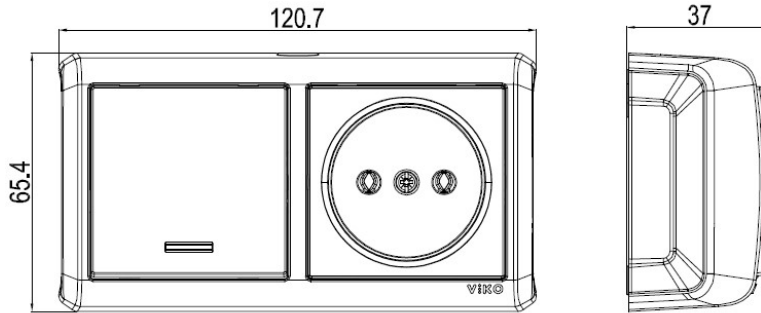

Panasonic Electric Works Elektrik.San. ve Tic. A.Ş.
Abdurrahmangazi Mah. Ebubekir Cad. No: 44 Sancaktepe / İstanbul Tel: 0216 564 55 55 Fax: 0216 564 55 44
ewtr.panasonic.com