

PRODUCT DATA SHEET



Product Name :	TV Socket, Through-Pass 8 dB
Product Code :	90681059
Product Series :	Vera
Material :	
<i>Outer Body :</i>	PP
<i>Cover :</i>	ABS
<i>Mechanism :</i>	PC
Certificates :	CE, PGD, WEEE
IP Degree:	IP20



Product Details:

- Suitable for central antenna and CATTV.
- Not affected by the parasite signals coming from the air for shielding feature.
- Ease of assembly thanks to the rear cover with hinge feature.
- Can be used in TV Socket 5-1000 MHz band.
- RG 6 U6 type wire connection is recommended for the image quality.

Transitive 8dB TV Socket

	TV				
f/MHz	5-47	47-470	470-862	862-1000	1000
Subscriber Loss (dB)	≤3,5				
Transient Loss (dB)	≤15	≤15	≤15	≤15	≤15,5

Dimensions:

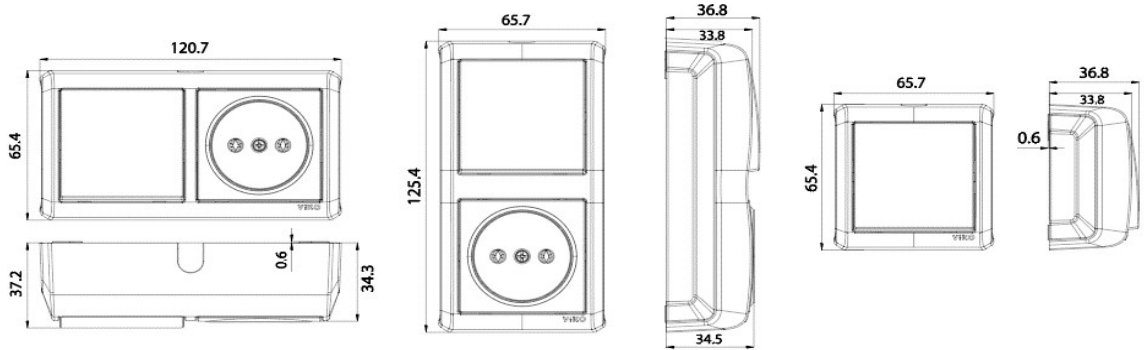

Panasonic Electric Works Elektrik.San. ve Tic. A.Ş.

Abdurrahmangazi Mah. Ebubekir Cad. No: 44 Sancaktepe / İstanbul Tel: 0216 564 55 55 Fax: 0216 564 55 44

ewr.panasonic.com