

PRODUCT DATASHEET

V:KO
by **Panasonic**

Product Name : 3-Gang One Way Switch

Product Code : 90967068

Product Series : Linnera/Rollina

Technical Specifications:

Rated Current : 10AX, 250V~

Terminal Type : Screw Terminal

Material : ABS (Acrylonitrile Butadine-Styrene)

Colour Options : White, Beige

Certificates : TSE, VDE, NF, EAC, CE, WEEE

Cable Standard :

Cable Diameter : 1mm²-2,5mm²

Applicable Cable: Solid Wire, Stranded Wire

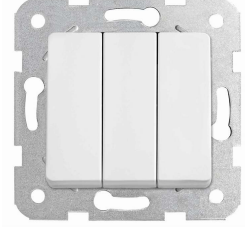

Screw
Terminal

Wiring Diagram:

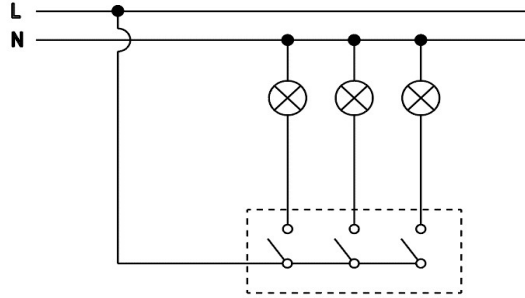
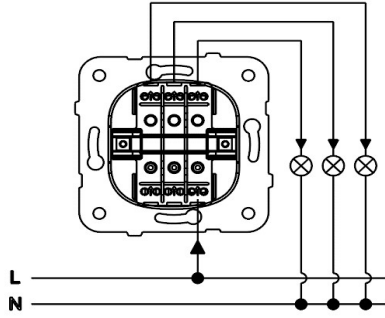

Dimensions:

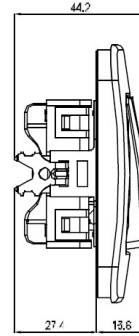
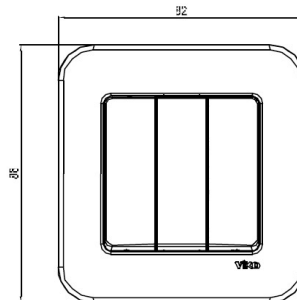
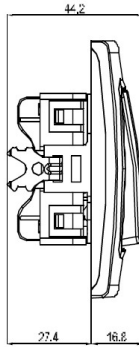
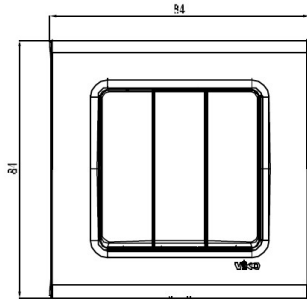

Panasonic Electric Works Elektrik.San. ve Tic. A.Ş.

Abdurrahmangazi Mah. Ebubekir Cad. No: 44 Sancaktepe / İstanbul Tel: 0216 564 55 55 Fax: 0216 564 55 44

ewtr.panasonic.com